

SensorDIM™ - Integrated HF Sensor and LED Driver

HEC6028 HEC6018
Tri-level Control Version

HYTRONIK®

Applications

Occupancy sensor and single constant current LED driver, 2-in-1.



Suitable for building into the fixture for:

- Office / Commercial Lighting
- Classroom
- Meeting Room

Use for retrofit and new luminaire designs/installations



Features

-  Tri-level dimming control based upon occupancy (also known as corridor function)
-  Easy-on-the-eye operation which makes the light turning on/off less uncomfortable
-  5 Year, 50,000hr Warranty

Technical Data

Input Characteristics

Model No.	HEC6028	HEC6018
Input current	0.15 - 0.14A	0.09 - 0.08A
Input power	32.5W	20W
Mains voltage	20s	
Warming-up	220~240VAC 50/60Hz	

Driver Data

Model No.	HEC6028	HEC6018
Empty load voltage	56V	50V
Output LED current	700mA	500mA
Output LED voltage	23~40VDC	23~36VDC
Output LED power	16~28W	11.5~18W
Power factor	≥0.9	
Efficiency	85% (Max.)	

Safety and EMC

EMC standard (EMC)	EN55015, EN61547, EN6100-2/3
Safety standard (LVD)	EN61347-1, EN61347-2-13
Dielectric strength	Input→output: 3750VAC / 5mA / 1min
Abnormal protection	Output short-circuit protection
Certification	Semko, CB, CE, EMC, RED, SAA

Sensor Data

Model No.	HEC6028 HEC6018
Sensor principle	High Frequency (microwave)
Operation frequency	5.8GHz +/- 75MHz
Transmission power	<0.2mW
Detection range	Max. (∅ x H) 8m x 5m
Detection angle	30° ~ 150°
Setting adjustments:	
Sensitivity	50% / 100%
Hold time	5s ~ 10min (selectable)
Daylight threshold	2 ~ 50 lux, disabled
Stand-by period	0s / 30s / 10min / +∞
Stand-by dimming level	10% / 30%

Environment

Operation temperature	Ta: -20°C ~ +50°C
Case temperature (Max.)	Tc: +75°C
IP rating	IP20

CE  RED  SAA CB IP20

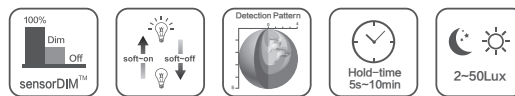
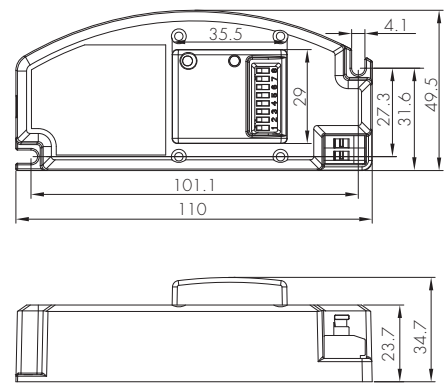
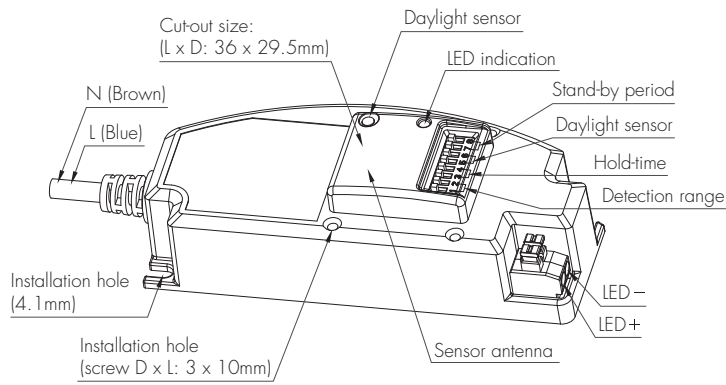

Functions and Features

1 Tri-level Control (Corridor Function)

Hytronik builds this function inside the motion sensor to achieve tri-level control, for some areas which require a light change notice before switch-off. The sensor offers 3 levels of light: 100%→dimmed light→off; and 2 periods of selectable waiting time: motion hold-time and stand-by period; Selectable daylight threshold and freedom of detection area.

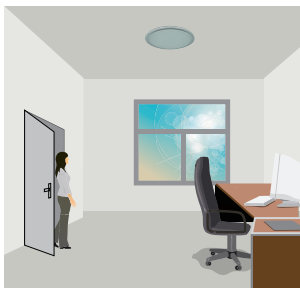

With sufficient natural light, the light does not switch on when presence is detected.

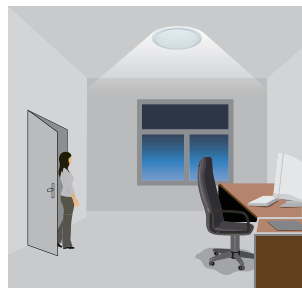

With insufficient natural light, the sensor switches on the light automatically when presence is detected.

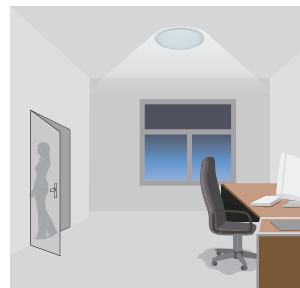

After hold-time, the light dims to stand-by level preset.

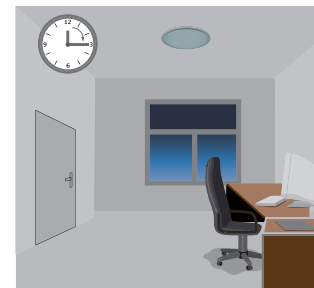

Light switches off automatically after the stand-by period elapses.

2 Assembly

The sensor antenna features the DIP switches (or rotary switch) and protrudes the LED panel. This feature enables the end user to access the sensor settings without removing the gear tray / LED board.

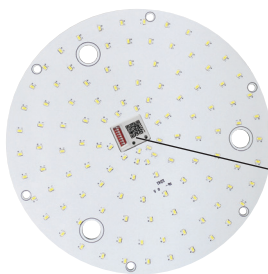

The QR code links the installer to the user manual on the on-line user guide to check the detail of settings (program).

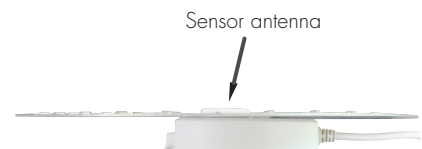

Cutout size: 36 x 29.5 (mm)

Detection Pattern

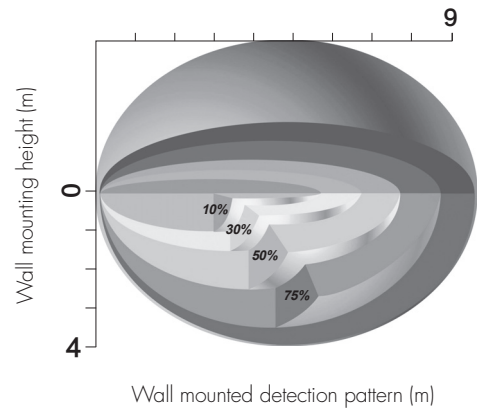
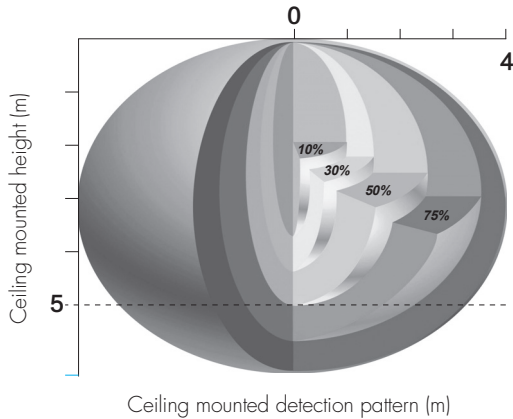

DIP Switch Settings

1 Detection Range

Sensor sensitivity can be adjusted by selecting the combination on the DIP switches to fit precisely for each specific application.

	1		
I	●	100 %	I – 100%
II	○	50%	II – 50%

2 Hold Time

Select the DIP switch configuration for the light on-time after presence detection. This function is disabled when natural light is sufficient.

	2	3	
I	●	●	5s
II	●	○	30s
III	○	●	3min
IV	○	○	10min

3 Daylight Threshold

Set the level according to the fixture and environment. The light will not turn on if ambient lux level exceeds the daylight threshold preset.

Please note that the ambient lux level refers to internal light reaching the sensor.

Disabling the daylight sensor will put the sensor into occupancy detection only mode.

	1	2	
I	●	●	Disable
II	●	○	50Lux
III	○	●	10Lux
IV	○	○	2Lux

4 Stand-by period (corridor function)

This is the time period you would like to keep at the low light output level before it is completely switched off in the long absence of people.

Note: "0s" means on/off control; "+∞" means the stand-by period is infinite and the light never switches off but stays at dimming level.

	6	7	
I	●	●	0s
II	●	○	30s
III	○	●	10min
IV	○	○	+∞

5 Stand-by dimming level

The setting is used to select the desired dimmed light level used in periods of absence for enhanced comfort and safety.

	8	
I	●	10%
II	○	30%