

HBT01 / HBT02



Applications

The freedom of wireless mesh networks configured by smartphone APP's considerably changes the approach to connected lighting controls. Hytronik has designed such lighting controls using  Bluetooth® 4 wireless mesh technology to support the functional demands of most commercial and industrial applications:

- Office / Commercial Lighting
- Classrooms
- Car Parks
- Stairwells / Corridors
- High-bay / Low-bay warehouse

HBT01 Transceiver + Occupancy Sensor Node

By combining the mesh network transceiver, microwave occupancy sensor and photocell into a single unit, many energy saving and comfort/safety control functions may be achieved. Perfect for applications such as car parks, stairwells and suspended fixtures where space is restricted for cables and traditional externally mounted lighting controls.



HBT02 Transceiver Node







This device contains all the features of the HBT01 above, except for the microwave occupancy sensor. These transceiver nodes generally make up the majority of the mesh network and may either be linked to the occupancy nodes for automated control, or are also able take commands from elsewhere, such as the Hytronik scene plate wall switch or App.

Both HBT01 and HBT02 nodes may be used with our broadcast DALI and 1-10V PSU's or even connected directly to any of our Hex-drive LED driver range for a powerful, cost effective & complete solution.

 Bluetooth® 4 wireless mesh lighting control with DALI or 1-10V output

Free smartphone App for set-up and commissioning

Features

-  30mA Broadcast DALI output for up to 15 LED drivers per node
-  1-10V output control option
-  Photocell Advance™ built-in daylight control.
-   Switch-Dim with Synchronization for simple manual over-ride
-  Permanent Settings Memory, Protected against Loss of Power
-  5 Year, 50,000hr Warranty



Note:

This datasheet is intended for information related to the hardware only.

For detailed set-up of features available in the App, please refer to the App user guide available from our website.



Compatible with iOS 8.0 or later



Android version coming soon...

**Preliminary Data Sheet: Contact ADM on 1300 235 467
to Confirm Specifications**

Technical Data For Transceiver Node (HBT01 / HBT02)

HF Sensor Properties (HBT01 only)	
Sensor principle	High Frequency (microwave)
Operation frequency	5.8GHz +/- 75MHz
Transmission power	<0.2mW
Detection range ¹	Max. (Ø x H) 10m x 3m
Detection angle	30° ~ 150°

Environment	
Operation temperature	Ta: -20°C ~ +70°C
Case temperature (Max.)	Tc: +70°C
Storage temperature	-35°C ~ 80°C
Max. relative humidity	0 ~ 90%
IP rating	IP20

Radio Transceiver	
Operation frequency	2.4 GHz - 2.483 GHz
Transmission power	Max.7.5 dBm
Range (Typical) ²	15~30m

HF Occupancy Detection Pattern

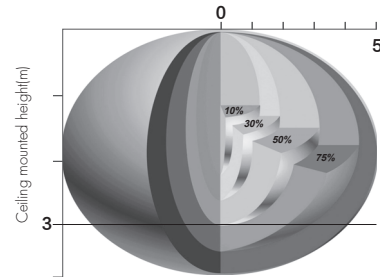

1. The detection range is heavily influenced by antenna placement (angle of approach) and different walking paces. It may be reduced to (Ø x H) of 2 x 3m under certain conditions.
2. Please refer to placement guidance provided later in this document .

Technical Data For Control Base (HC038V / HCD038)

Input Characteristics	
Mains voltage	220~240VAC 50/60Hz
Stand-by power	<0.5W
Load ratings:	
HC038V	400W (capacitive) 800W (resistive)
HCD038	30mA, 16VDC (max. 15 devices)
Warming-up	20s

Environment	
Operation temperature	Ta: -20°C ~ +55°C
Case temperature (Max.)	Tc: +80°C
IP rating	IP20

Safety and EMC (Common Data)	
EMC standard (EMC)	EN55015, EN61000
Safety standard (LVD)	EN60669, AS/NZS60669
Radio Equipment (RED)	EN300440, EN301489, EN62479
Certification	Semko, CB, CE, EMC, RED, RCM

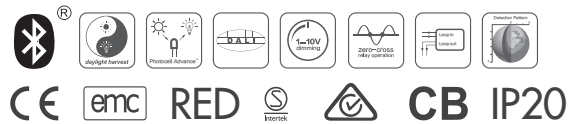

Dimensions and Terminals

Transceiver Node (HBT01 / HBT02)

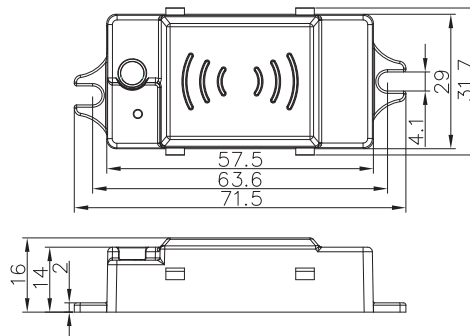
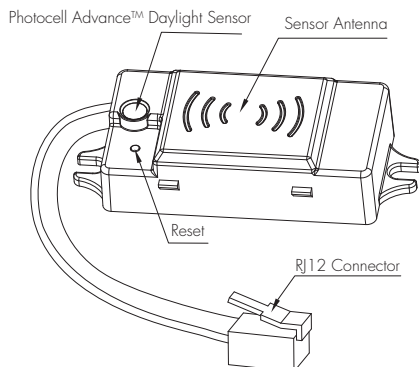

Preliminary Data Sheet: Contact ADM on 1300 235 467 to Confirm Specifications

Control Base (HC038V / HCD038)

HC038V (1-10V output)

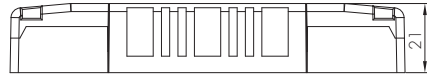
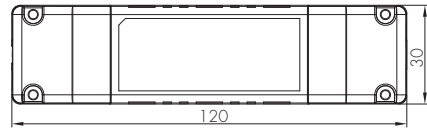
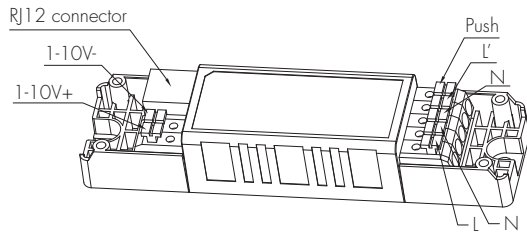

HCD038 (DALI output)

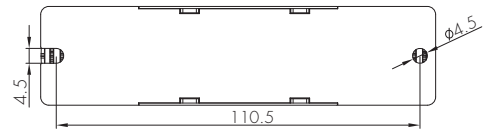
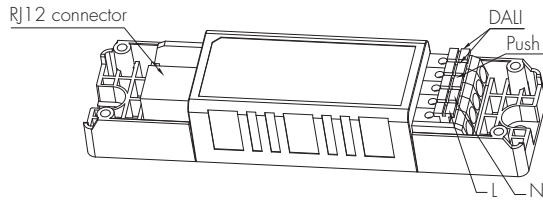

Wire Preparation

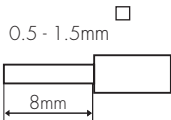
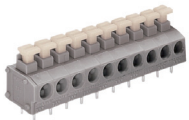

To make or release the wire from the terminal, use a screwdriver to push down the button.

Wiring Diagram

DALI version

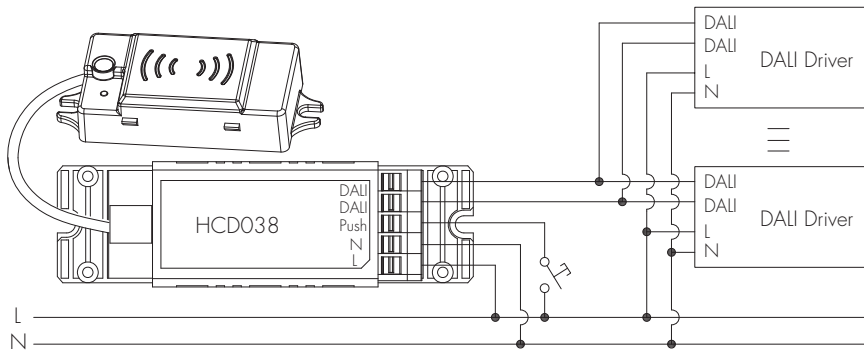

1-10V version

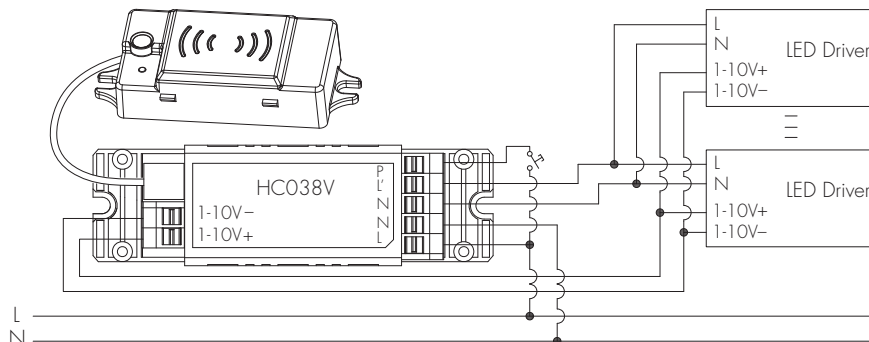

Preliminary Data Sheet: Contact ADM on 1300 235 467 to Confirm Specifications

To maximise the range in every direction, the following considerations should be taken into account when situating the antenna in the luminaire:

HBT01

The HBT01 contains both a HF microwave antenna and the **Bluetooth** transceiver module and are located within the device as per fig. 1.

HF Microwave Antenna

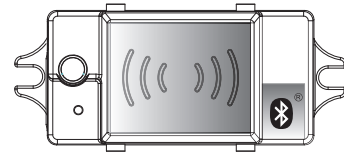
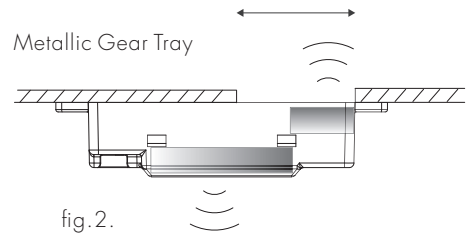

fig. 1. **Bluetooth** Antenna

When the antenna is mounted to a metallic backplane, such as a gear tray a cut-out opening should be made as large as possible as shown in fig. 2.

If possible, try to position the sensor as far away as possible from the LED Driver or other strong sources of HF interference.

Opening under antenna



HBT02

The HBT02 contains only the **Bluetooth** transceiver module and is located in the same position as per fig. 3. The same consideration to mounting on metal gear trays is therefore also as per fig. 2.

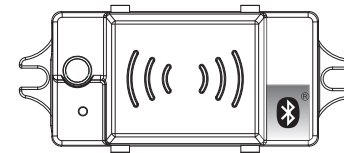
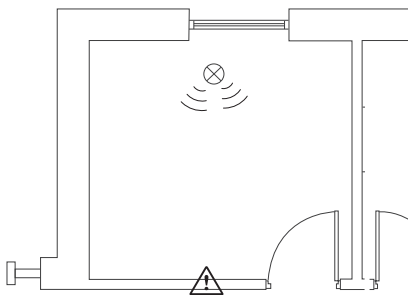
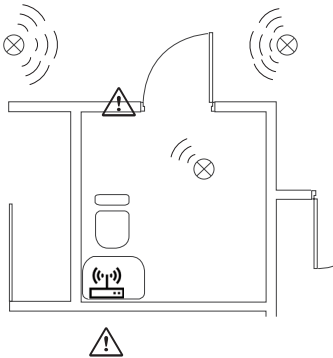

fig. 3. **Bluetooth** Antenna

Device to Device Placement



Concrete walls
Metals, and other
building materials
will reduce the range



Strong signal sources such as WiFi routers and microwave ovens will affect the range

Smart Phone to Device Range

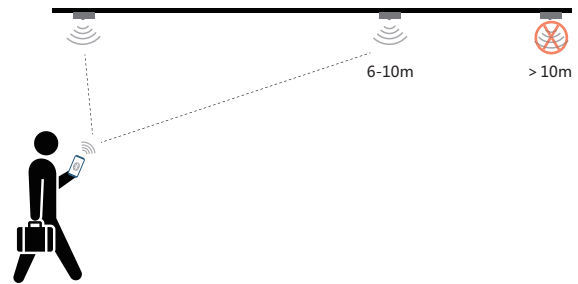

Notes:

The range for which a smart phone can communicate with the lighting points will vary from model to model and is dependant on its **Bluetooth** capability

Placement of the antenna within the luminaire will also effect the smart phone communication range and may appear different for each luminaire variant.

Finally, other environmental factors (as per opposite) will influence the ultimate achievable range of communication between smart phone and luminaire device.

Device placement may offer upto 30m communication distance. However, we recommend for indoor applications that device placements should be no further apart than 15m.

Preliminary Data Sheet: Contact ADM on 1300 235 467 to Confirm Specifications

Hardware Features

1 Manual Override (HCD038 / HC038V 'Push' Terminal)

The Switch-Dim terminal reserves the access of manual override function for the end-user to switch on/off, or adjust the light level by push-switch. Furthermore, by using the "push-sync" option in the App, entire groups of fixture may be wirelessly controlled by a single switch. Please refer to the App user guide for further information.

* Short Push (< 1s): on/off function;

On → Off: the light turns off immediately and cannot be triggered ON by motion until the expiration of pre-set hold-time. After this period, the sensor goes back to normal sensor mode.

Off → On: the light turns on and goes to sensor mode, no matter if ambient Lux level exceeds the daylight threshold or not.

* Long Push (> 1s): adjust the target lux level by turning the light up or down. Both the adjustment on App and push switch can overwrite each other, the last adjustment remains in memory.

Note: If this feature is not required, simply leave the "push" terminal unconnected.

2 Photocell Advance™ Function (Built into HBT01 / HBT02)

It's well known that LED lights have a totally different spectrum to natural light. Hytronik uses this principle with a custom-designed photocell and sophisticated software algorithm to measure and differentiate natural light from LED light, so that this photocell can ignore the LED light and only respond to the natural light.

3 Zero-cross Relay Operation (HC038V)

Designed into the software, the relay switches the load right at the zero-crossing point, to ensure that the in-rush current is minimised thus enabling the maximum lifetime of the relay.

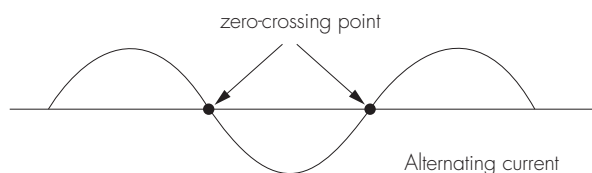

4 Hardware Reset Button

The HBT01 and HBT02 feature a hardware reset button which will Erase the device from any mesh network it may have been added to. The sensor and Photocell Advance™ settings will be re-set to the factory defaults as in the table below:

Tri Level Default Settings					HF Sensor and Photocell			Daylight Harvest				CCT			Global
Hold Time	Hold Time Level	Stand-by Time	Stand-by Level	Fade Time	Sensitivity (HBT01 only)	Sensor Link	Photocell Advance™	Start Output Brightness	End Output Brightness	Start Natural Light	End Natural Light	CCT	CCT Max	CCT min	Min Brightness Level
5S	100%	0S	10%	0.7S	100%	Enabled	Disabled	100%	10%	30 Lux	300 Lux	2000K	8000K	2000K	10%

Note: Dimming mode refers to either tri-level control or daylight harvest control, daylight harvest is disabled as default.

To perform the reset:

* The HBT01/HBT02 must be connected and powered up.

* Press and hold the reset button until the lamp flashes twice to confirm the reset is complete (It will take around 2- 5 Seconds).

A HBT01/HBT02 may also be removed from a Network via the App via the devices menu and it is recommended that points be removed using the App. Please refer to the App user manual for further details.

This feature is provided in the case that the network has accidentally been deleted from within the App, or the device is otherwise undiscoverable in a device search.

**Preliminary Data Sheet: Contact ADM on 1300 235 467
to Confirm Specifications**