

IP65 High Bay HF Motion Sensor



HYTRONIK®

HMW38/RF

1-10V Dimming with RF Wireless Transmission

Technical Data

Input Characteristics

Model No.	HMW38/RF
Mains voltage	120~277VAC 50/60Hz
Stand-by power	<1.5W
Load ratings:	
Capacitive	400VA@120V; 800VA@220-277V
Resistive	800W@120V; 1600W@220-277V
HCO34RF (IP20)	400W (capacitive); 1200W (resistive)
HCO54RF (IP20)	400W (capacitive); 1200W (resistive)
HCO64RF (IP20)	max. 20 devices, max. 40mA
Warming-up	20s

Safety and EMC

EMC standard (EMC)	EN55015, EN61000
Safety standard (LVD)	EN60669-1, EN60669-2-1
Radio Equipment (RED)	EN300440, EN301489-1, EN62479
Certification	Semko, CB, CE, EMC, RED, SAA

Sensor & RF Data

Model No.	HMW38/RF
Sensor principle	High Frequency (microwave)
Operation frequency	5.8GHz +/- 75MHz
Transmission power	<0.2mW
Detection range	Max. (Ø x H) 10m x 12m
Detection angle	360°
RF frequency	868MHz (FSK mode)
RF transmission distance	30m indoor, 50m outdoor

Environment

Operation temperature	Ta: -20°C ~ +70°C
IP rating	IP65

CE emc RED SAA CB IP65

Mechanical Structures and Installations

For more details, please refer to user manual.

A. Ceiling mount

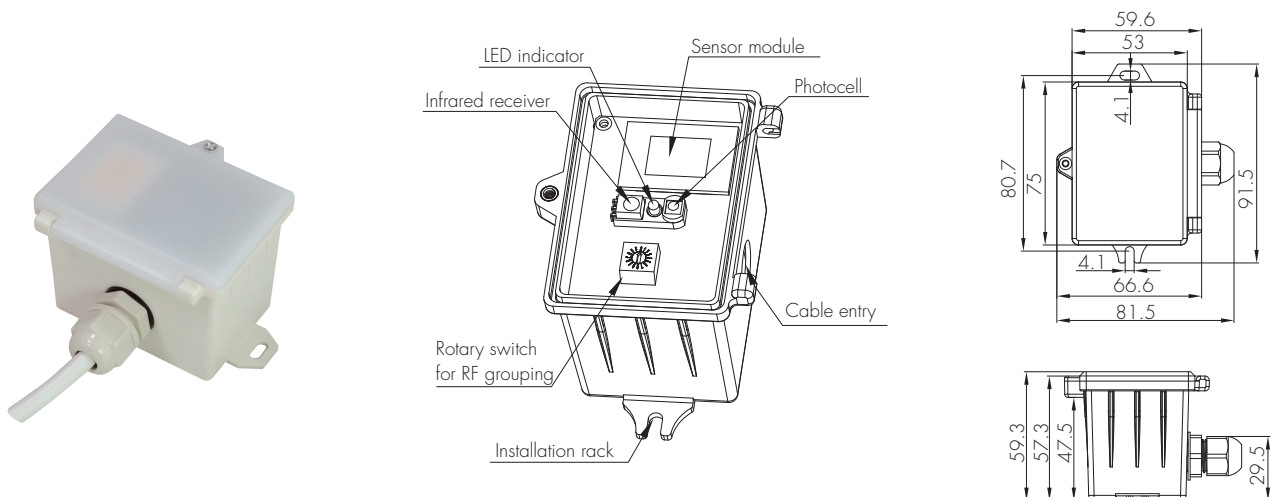

B. Screw to the Luminaire by conduit

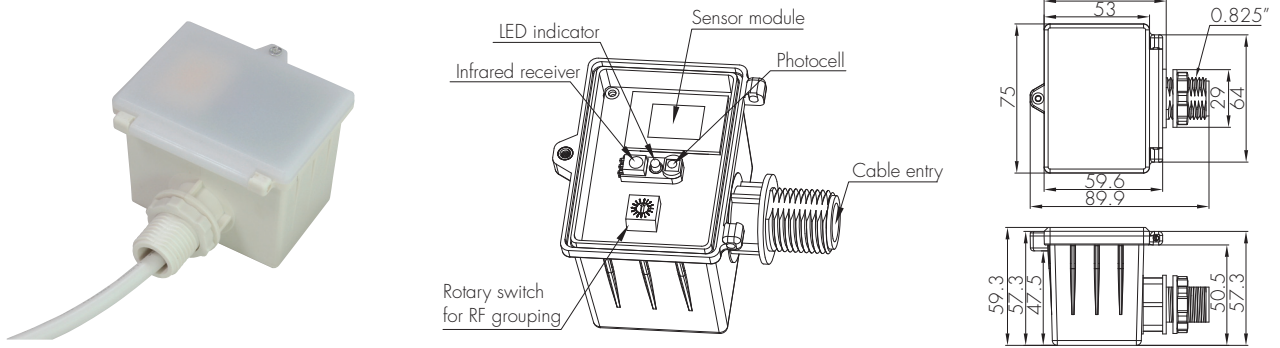

C. Attach to the shade by clamp

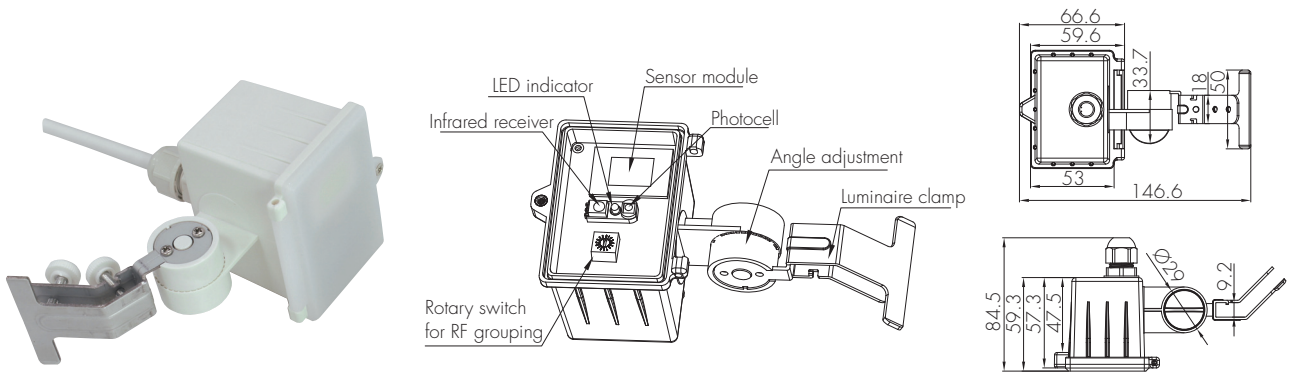

The motion detected by the master unit HMW38/RF passes to all other units programmed on the same group via RF transmission. The transmission can reach 30 meters indoor and 50 meters in open areas. A daylight sensor is also built-in to prevent the light switching on when surrounding natural light is sufficient.

RF receiver serves as slave only, which turns on the light after receiving the RF "ON" signal from the master. Total 3 receivers for different applications:

Option ① : HC034RF (1-10V output, RF grouping by rotary switch or remote control)

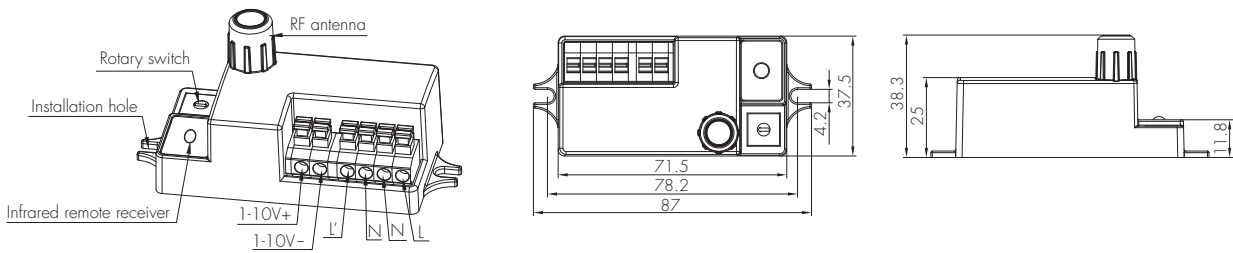

Option ② : HC054RF (1-10V output with Photocell Advance™)

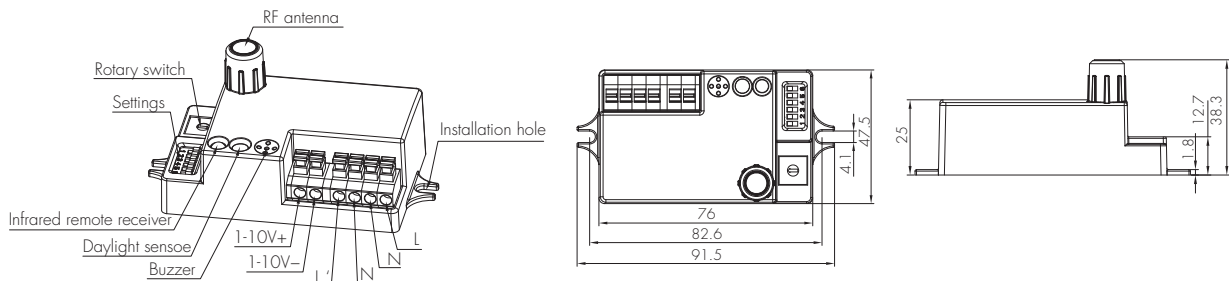

Option 3 : HC064RF (DALI output with Photocell Advance™)

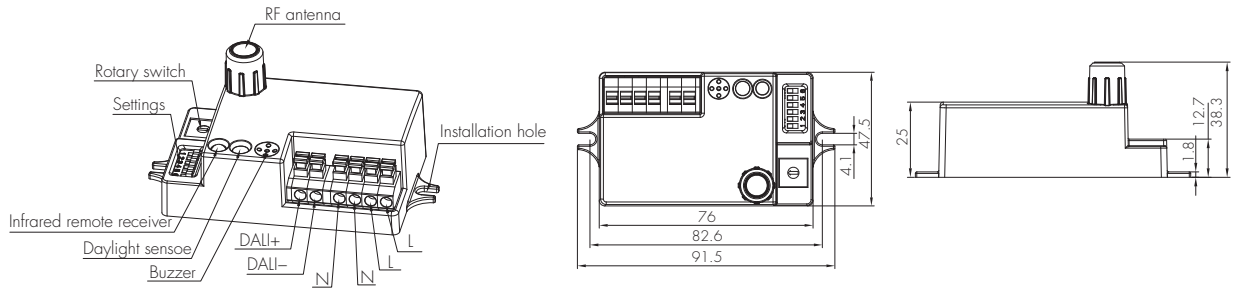

Functions and Features

1 Tri-level Control (Corridor Function)

Hytronik builds this function inside the motion sensor to achieve tri-level control, for some areas which require a light change notice before switch-off. The sensor offers 3 levels of light: 100% → dimmed light (natural light is insufficient) → off; and 2 periods of selectable waiting time: motion hold-time and stand-by period; Selectable daylight threshold and freedom of detection area.

2 Intelligent Photocell (daylight detection prior to motion detection)

The built-in photocell will also automatically turn off the light when the ambient natural light exceeds the programmed lux level for more than 5min, regardless of whether motion is detected or not. This feature can be disabled if it is required that the fixture stays at dimmed level during absence.

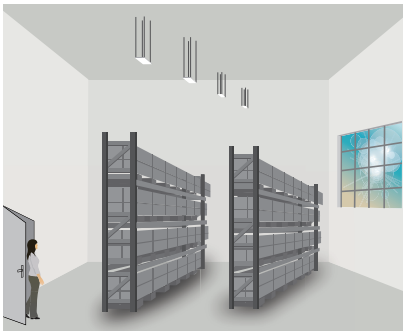

With sufficient natural light, the light does not switch on when presence is detected.



With insufficient natural light, the sensor switches on the light automatically when presence is detected.



The sensor switches off the light when natural light is sufficient, even with presence.

Note: if the stand-by time is preset at "+∞", the fixture never switches off but stays at preset dimming level even when natural light is sufficient.

3 Photocell Advance™ Function (HC054RF & HC064RF)

It's well known that LED lights have a totally different spectrum to natural light. Hytronik uses this principle and comes up with special photocell and sophisticated software algorithm to measure and differentiate natural light from LED light from behind the fixture cover, so that this photocell can ignore internal LED light and only respond to the natural light outside. Our technology has no infringement to the existing patents in the market.

4 Zero-cross Relay Operation

Designed in the software, sensor switches on/off the load right at the zero-cross point, to ensure that the in-rush current is minimised, enabling the maximum lifetime of the relay.

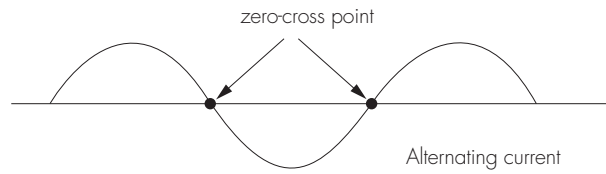

RF Grouping by Rotary Switch (Maximum 15 channels)

15 channels are available for fast grouping via rotary switch on both HMW38/RF and the receiver HCO34RF, HCO54RF, HCO65RF. Simply selecting the same channel on each unit, the grouping is automatically completed.

Noted: channel "0" is not for fast grouping, and sensors can only be grouped by remote control.

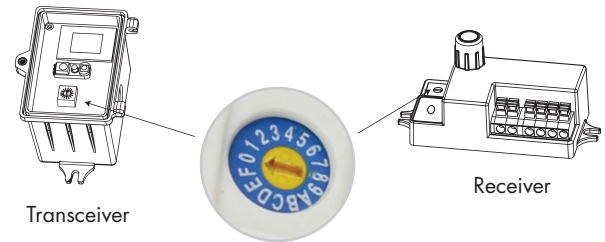

Typical Applications

1 For warehouse (HMW38/RF as both transmitter and receiver)

Settings on this demonstration:

Detection range: 100% Hold-time: 10min Daylight threshold: 100lux Stand-by dimming level: 30% Stand-by period: 10min RX: STBY%

Night

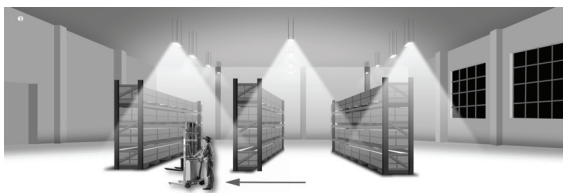

Daytime

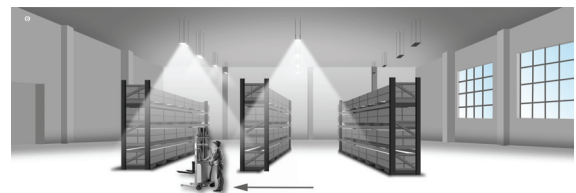
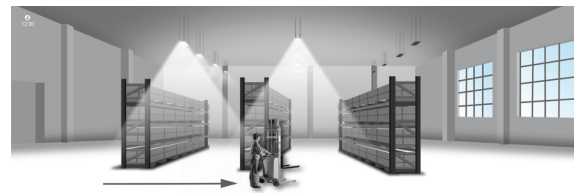

Settings (Remote Control HRC-11)

Permanent ON/OFF function

Press button "ON/OFF" to select permanent ON or permanent OFF mode.
* Press button "AUTO", "RESET" to quit this mode.

Reset Settings

Press button "RESET", all settings go back to default settings.

Shift Button

Press button "Shift", the LED on the top left corner will flash to indicate mode selection. All values / settings in RED are valid for 20 seconds.

AUTO mode

Press button "AUTO" to initiate automatic mode. The sensor starts working and all settings remain as before the light is switched ON/OFF.

Note: "Semi-auto" function is disabled.

Power output

Press the buttons to select light output at 80% (at initial 10,000 hours) or 100%.

Note: "Sensor off" and "Twilight" functions are disabled.

Brightness +/-

Press the buttons to adjust the light brightness during hold-time.

Scene program - 1-key commissioning

1. Press button "Start" to program.
2. Select the buttons in "Detection range", "Daylight threshold", "Hold-time", "Stand-by time", "Stand-by dimming level" to set all parameters.
3. Press button "Memory" to save all the settings programmed in the remote control.
4. Press button "Apply" to set the settings to each sensor unit(s).

For example, to set detection range 100%, daylight threshold Disable, hold-time 5min, stand-by time +∞, stand-by dimming level 30%, the steps should be: Press button "Start", button "100%", "Disable", "Shift", "5min", "Shift", "+∞", "30%", "Memory". By pointing to the sensor unit(s) and pressing "Apply", all settings are passed on the sensor(s).

Detection range (for Transceiver only)

Press buttons in zone "Detection range" to set detection range at 100% / 75% / 50% / 10%.

Daylight threshold

Press buttons in zone "Daylight threshold" to set daylight sensor at 2Lux / 10Lux / 50Lux / 100Lux / 300Lux / 500Lux / Disable.

Note: To set daylight sensor at 100Lux / 300Lux / 500Lux, press "Shift" button first.

Disabled for HC034RF.

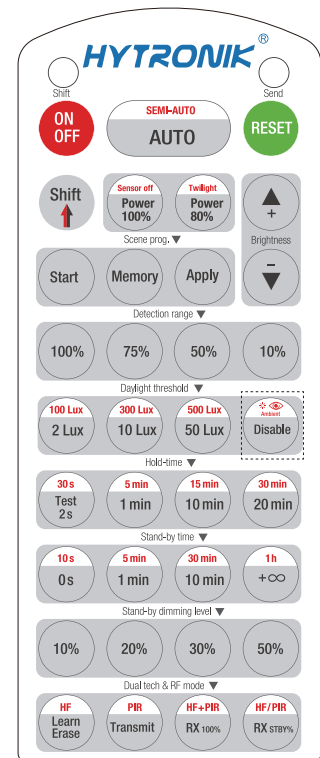

HRC-11

Load Indication:

The light will flash ONCE rapidly after receiving the command from the remote control successfully.

Ambient daylight threshold

1. Press button "Shift", the red LED starts to flash.
2. Press button "Ambient", the surrounding lux level is sampled and set as the new daylight threshold.

Hold-time

Press buttons in zone "hold-time" to set the hold-time at 2s / 30s / 1min / 5min / 10min / 15min / 20min / 30min.

Note: 1. To set hold-time at 30s / 5min / 15min / 30min, press "Shift" button first.

2. 2s is for testing purpose only, stand-by period and daylight sensor settings are disabled in this mode.

*To exit from Test mode, press button "RESET" or any button in "Hold-time".

Stand-by time (corridor function)

Press buttons in zone "stand-by time" to set the stand-by period at 0s / 10s / 1min / 5min / 10min / 30min / 1h / +∞.

Note: "0s" means on/off control; "+∞" means bi-level control, the fixture is 100% on when there is motion detected, and remains at the stand-by dimming level when no presence after motion hold-time.

Stand-by dimming level

Press the button in zone "stand-by dimming level" to set the stand-by dimming level at 10% / 20% / 30% / 50%.

Dual tech & RF mode

"HF", "PIR", "HF+PIR", "HF/PIR" are disabled.

For RF grouping via remote control, please refer to steps below:

RF grouping by HRC-11

Short press "Learn/Erase" button on RC to activate pairing mode, and the receiver unit starts to beep once every second for 3min.

Note: up to 30 units can be paired.



Short press "Transmit" button on RC, the commander unit (master unit) beeps one time to send the transmission signal.

Upon receiving the transmission signal, the receiver unit (slave unit) rapidly beeps 3 times in 1s to indicate the success of pairing. Repeat this step to pair more units.

One more short press on "Learn/Erase" button to the receiver unit to complete the pairing process, the receiver unit will quit the pairing mode.

Note: Press button RX100%, the light on receiver unit is 100% on upon receiving RF on signal; Press "RX STBY%" button, the light(s) goes to preset stand-by dimming level directly.

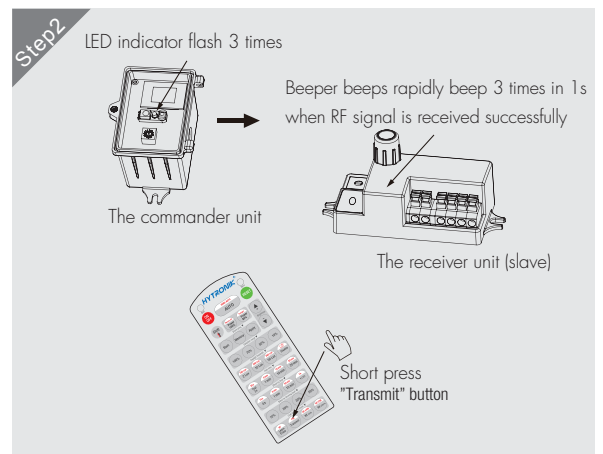

Erase:

Long press "Learn/Erase" button for 3s to the sensor unit. The beeper beeps rapidly for about 5s. All commands received before are erased.



Detection Pattern

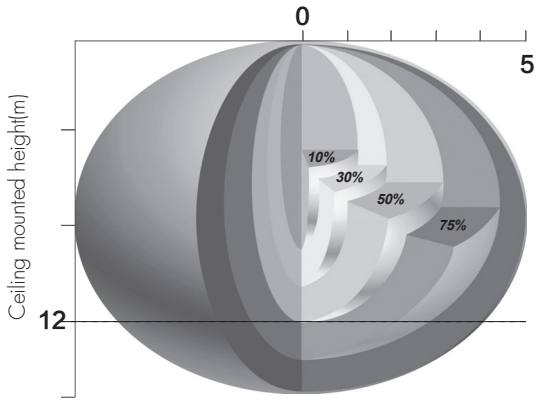

Wiring Diagram

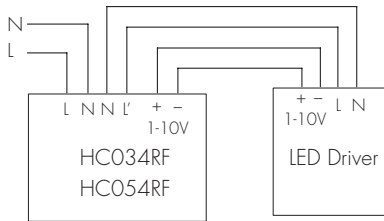
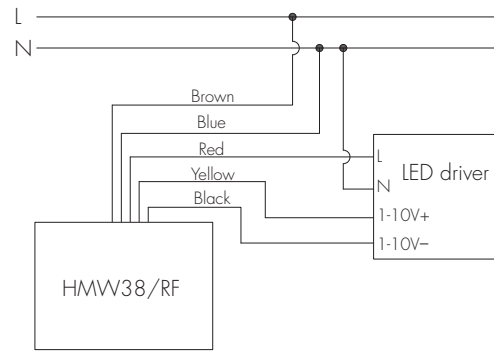

Wiring Diagram

