

HEM09 / HEM09H



**Applications**

Suitable for LED panels - insulated terminal cover with cord restraint:

- Office / Commercial Lighting
- Classrooms
- Utility / Back of house (Bulkhead)

Use for retrofit upgrades & new luminaire designs.

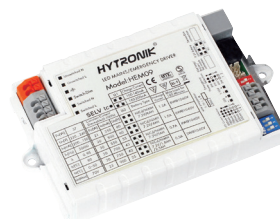

**Features**

- Combined LED Driver & Emergency
  - Multi-wattage
  - Self-Testing Emergency
  - Active PFC Design
  - 1-10V
  - Switch-Dim + Synchrony
  - Multiple Constant current selection
  - Intelligent Thermal Management
  - Over-heat Protection
  - Short Circuit Protection
  - Over-load Protection
- } All with Auto-restart
- 5 Year, 50,000hr Warranty (driver only)

- 3-hour and 1-hour emergency autonomy
- Tri-level sensorDIM™ motion detection antenna (optional)
- Hand-held remote control
- With 24hr daylight monitoring function

**Output Configuration**

HEM09

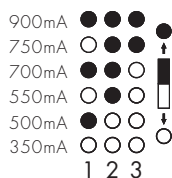

HEM09H

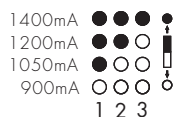

**Emergency Power Selection**

HEM09

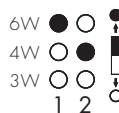

HEM09H



Model No.	HEM09	HEM09H	
Mains voltage	220~240VAC 50/60Hz	220~240VAC 50/60Hz	
Mains current	0.2~0.15A	0.22A - 0.16A	
Mains power	37W	42W	
Output LED current	18W/350mA/10~52V 28W/550mA/10~52V 30W/700mA/10~43V 30W/750mA/10~40V	26W/500mA/10~52V 30W/700mA/10~43V 23W/900mA/10~25V	30W/900mA/10~33V 30W/1050mA/10~29V 25W/1200mA/10~21V 20W/1400mA/10~14V
Output voltage(U-out Max.)	62V	33V	
Power factor	0.95	0.95	
Operation temperature	0~+50°C	0~+50°C	
Battery charge current	100 - 140mA / 160 - 200mA	100 - 140mA / 160 - 200mA	
Battery pack	BPC30, BPC31	BPC30, BPC31	
Battery Type / Discharge current / Max. load for 180min	NiMH 7.2V, 4AH / 1.0A / 6W@10-52V (HEM09); 6W@10-33V (HEM09H) NiMH 7.2V, 3AH / 0.7A / 4W@10-52V (HEM09); 4W@10-33V (HEM09H) NiMH 7.2V, 1.8AH or 2.5AH / 0.5A / 3W@10-52V (HEM09); 3W@10-33V (HEM09H)		
Battery duration	3 hours		
Charge period	24 hours		
Max. case temp.	80°C		
Over-heat protection	Over-heat protection with auto-reset.		
EMC standard	EN55015, EN61547, EN61000-3-2, EN61000-3-3		
Safety standard	EN61347-1, EN62493, EN61347-2-7		
Certifications	Semko, CB, SAA, CE, EMC		
Dielectric strength	Input→output: 3000VAC		
IP grade	IP20		

## Dimensions and Terminals

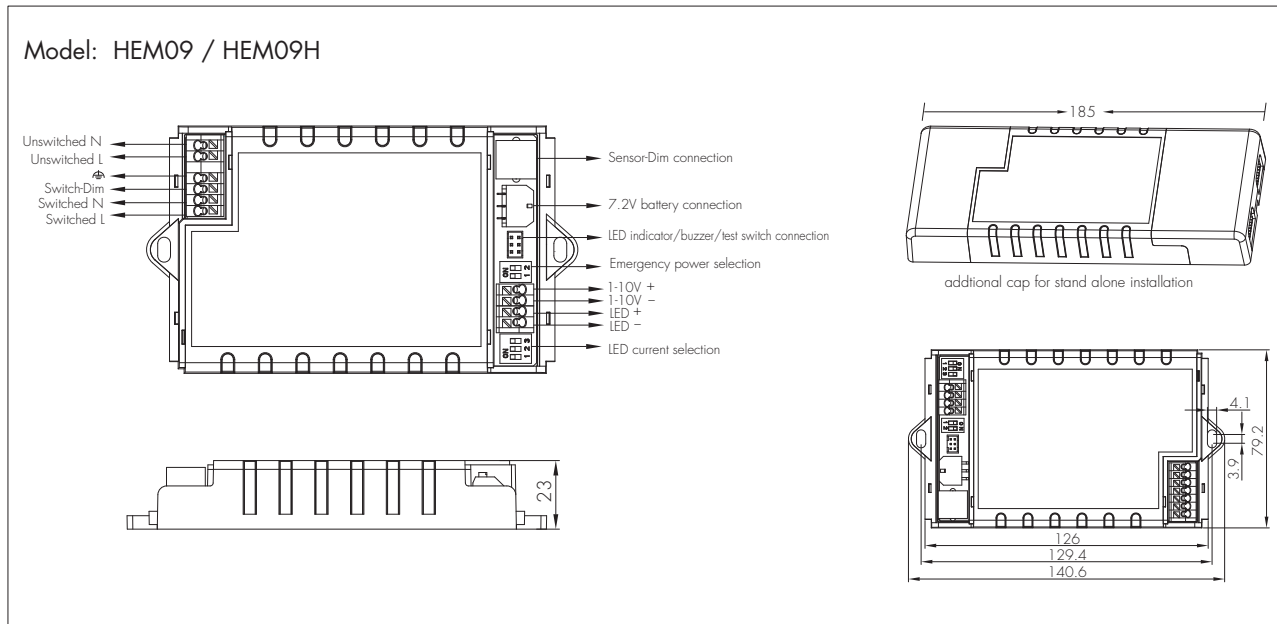

## Wire Preparation

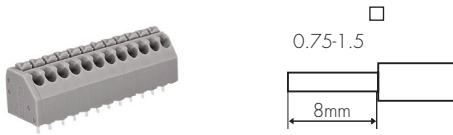

Solid or Stranded wire type 0.75 - 1.5mm<sup>2</sup>

To make or release the wire from the terminal, use a screwdriver to push down the button.

## Loading and In-rush Current

Model	HEM09	HEM09H
In-rush Current (I <sub>max.</sub> )	9A	9A
Pulse Time	180μs	180μs

## Number of Drivers Based upon 16A Circuit Breaker

Cct Breaker Type	HEM09	HEM09H
Type B	30	30
Type C	50	50

## Wiring Diagram

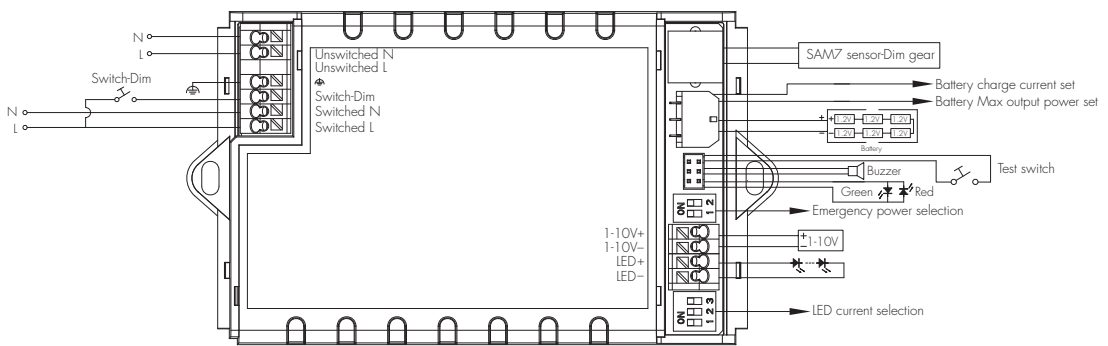

## Performance Characteristics

### HEM09

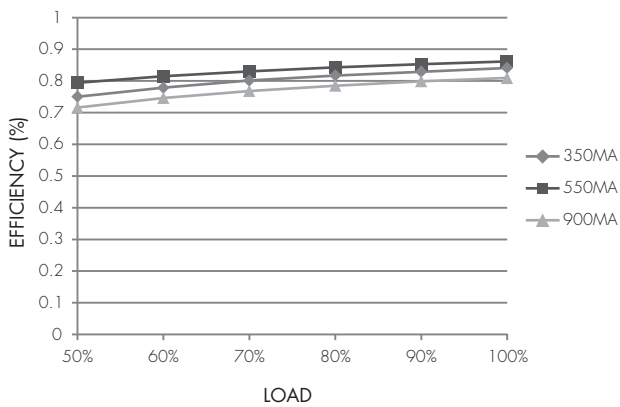

\* Typical Efficiency vs Load

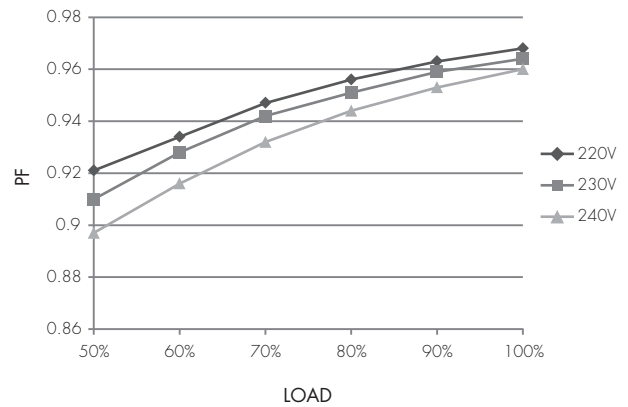

\* Typical Power Factor vs Load

## HEM09H

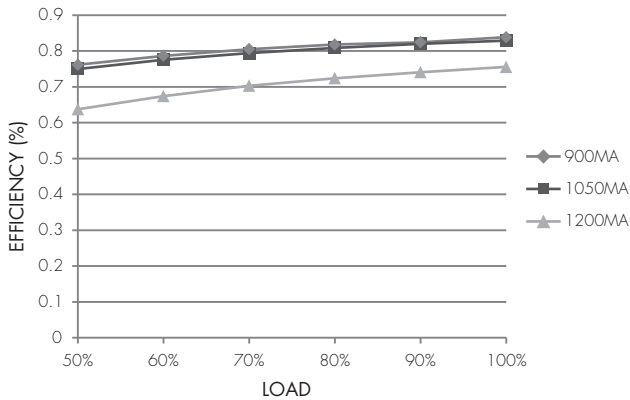

\* Typical Efficiency vs Load

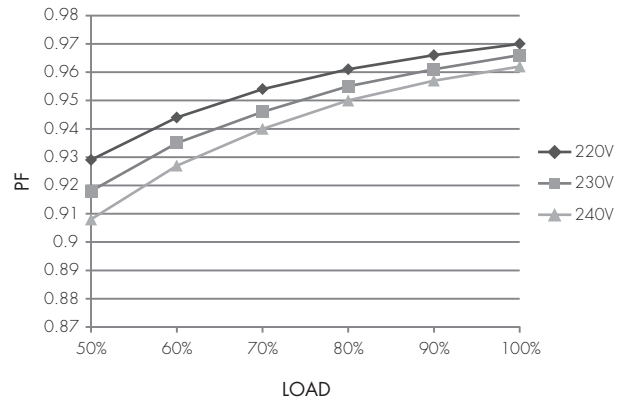

\* Typical Power Factor vs Load

## Performance Characteristics

### Switch-Dim Dimming Curve

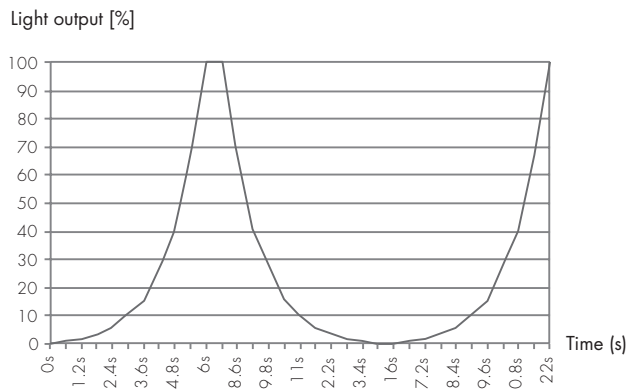

### 1-10V Dimming Curve

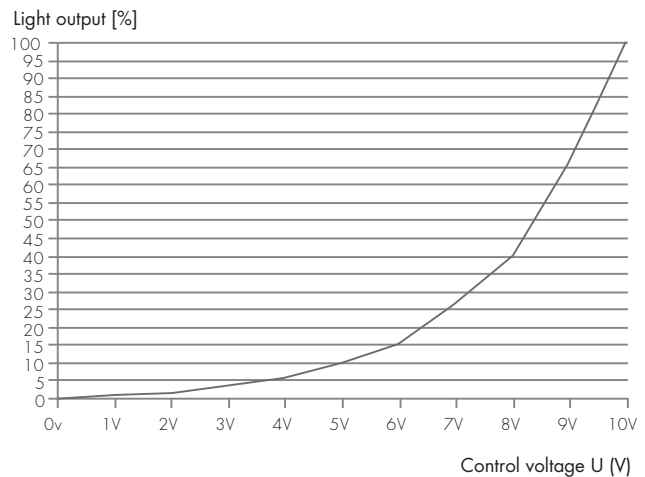

## Switch-Dim

The provided Switch-Dim interface allows a simple dimming method using commercially available non-latching (momentary) wall switches. Up to 50 LED drivers may be connected to one switch.

Switch Action  
 Short press (<1 second)  
 Long press (>1 second)

Response  
 Toggle light on / off  
 Toggle dim light / increase brightness

Synchronization  
 Switch Action  
 Long press (>15 seconds)

Response  
 All lights will dim down to minimum then return to 50% brightness

## 1-10V

The 1-10V input is operable via commercially available simple rotary wall switches designed for 1-10V dimming equipment or from dedicated system central dimming controllers.

Note: In the unlikely event that the LED driver be used with the Switch-Dim or interface prior to using the 1-10V interface, the 1-10V interface may need to be re-set. This is achieved by placing a short circuit across the 1-10V terminals until the light returns to full brightness (approx. 3-5 seconds).

## Self-testing Feature

Carrying out routine test on emergency lighting and holding records of the test result are required by law. (IEC62034, EN50172). Hytronik advanced LED emergency control model HEM09 / HEM09H has an internal clock, programmed at pre-determined intervals to perform the requested routine testing: 3min. functional test every month, and 3h functional test every 6 months.

- Self-test starts after the luminaires are connected to an un-interrupted mains supply for between 24 hours.
- Permanently monitors battery and charge condition
- Dual fault indication: faults are clearly identified on the luminaire by red LED and buzzer.
- Automatic random test to avoid adjacent luminaires being tested together, leaving the occupied space unprotected.

## Manual Testing

HEM09 / HEM09H is provided with a test switch which performs the following functions:

Monthly Test / Fault reset

\* Short push (<5s): Green LED flashes once, then goes to monthly 3 minute test mode. Providing the battery has sufficient charge, any fault indicators that have been rectified will be cleared.

6-month test initiation

\* Long push (>5s <10s): The buzzer beeps twice and the battery will start charging for 24h. After the re-charge period a 6-month duration test will be performed. The green LED will flash 2 times every 3 seconds during this discharge period.



Full duration test initiation

\* Long push (>10s): The buzzer beeps three times and a full duration discharge is initiated. The green LED will flash 3 times every 3 seconds during this discharge period.

## Bi-Colour LED Diagnostics

Status	Buzzer beep & LED flash mode	Visual indication	Buzzer
Battery voltage too low	Red LED slowly flashes once in 3 seconds; buzzer beeps 10 seconds every hour.	● ○ ○	
Battery open-circuit	Red LED flashes twice in 3 seconds; buzzer beeps 10 seconds every hour.	● ● ○	
Battery short-circuit	Red LED flashes 3 times in 3 seconds; buzzer beeps 10 seconds every hour.	● ● ●	
Battery reverse connection	Red LED flashes 3 times in 3 seconds; buzzer beeps 10 seconds every hour.	● ● ●	
LED load open-circuit	Red LED flashes 4 times in 3 seconds; buzzer beeps 10 seconds every hour.	● ● ● ●	
LED load short-circuit	Red LED rapidly flashes 5 times in 3 seconds; buzzer beeps 10 seconds every hour.	● ● ● ● ●	
Battery voltage too high	Red LED rapidly flashes 6 times in 3 seconds; buzzer beeps 10 seconds every hour.	● ● ● ● ● ●	
Healthy condition	Green LED is constantly on	● ● ● ● ● ●	
Battery charge	Green LED slowly flashes once every second	● ● ● ● ●	
Emergency mode	/	/	
Monthly test	Green LED slowly flashes once in 3 seconds	● ○ ○	
6 months test	Green LED flashes twice in 3 seconds	● ● ○	
12 months test	Green LED quickly flashes 3 times in 3 seconds	● ● ●	

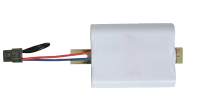
## Battery Options

Package code	Picture	Spec.	Size(mm)	Duration	Recharge Time	Accessories
BPC30		6 cells, high temperature SC NiCd battery, 7.2V, 1800mAh	175x50x30	180min.@3W	24Hrs	battery bracket, Green LED indicator, Buzzer, test switch
BPC31		6 cells, high temperature SC NiMH battery, 7.2V, 1800mAh	190x33x30	180min.@3W	24Hrs	battery bracket, Green LED indicator, Buzzer, test switch

NiCd - Continuously rated 55 degrees for 4 years design life

NiMH - Continuously rated 40 degrees for 4 years design life

Charge new battery for 24hours before use.

In compliance with IEC61951-1 (Nicc type), IEC61951-2 ( NiMH type).

## Antenna Attachment options

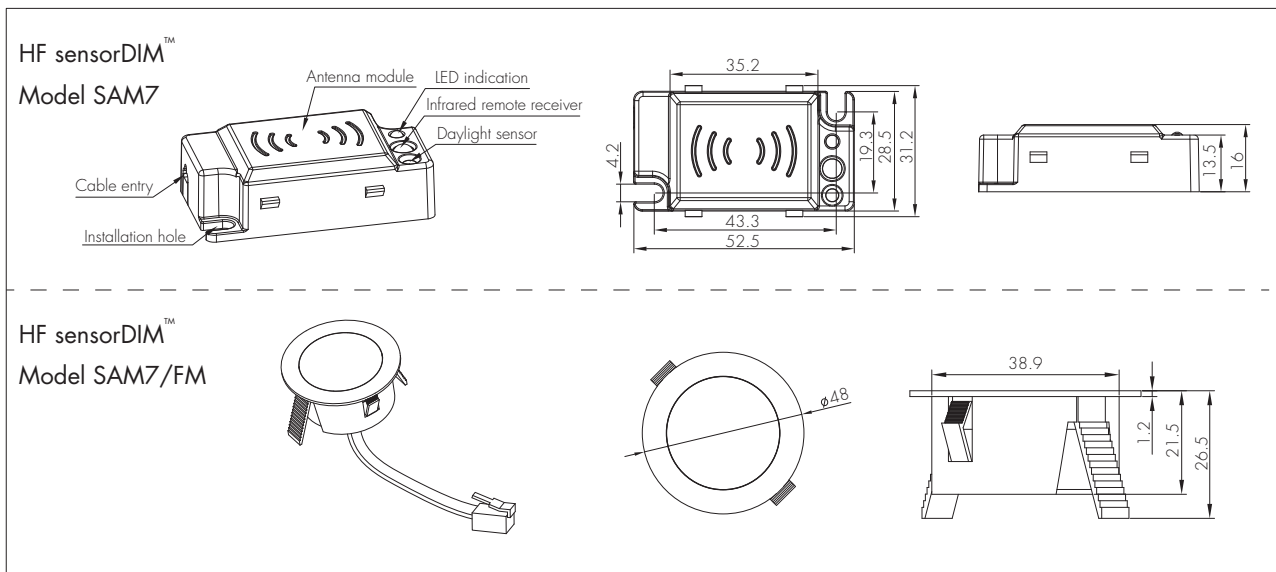

## Detection Pattern

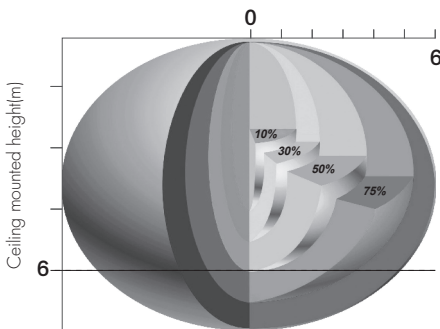

### HF Sensor Data

Sensor principle	High Frequency (microwave)
Operation frequency	5.8GHz +/- 75MHz
Transmission power	<0.2mW
Detection range	Max. (Ø x H) 12m x 6m
Detection angle	30° ~ 150°

### Tri-level Control (Corridor Function)

Hytronik builds this function inside the motion sensor to achieve tri-level control, for some areas which require a light change notice before switch-off. The sensor offers 3 levels of light: 100% -> dimmed light (natural light is insufficient) -> off; and 2 periods of selectable waiting time: motion hold-time and stand-by period; Selectable daylight threshold and freedom of detection area.

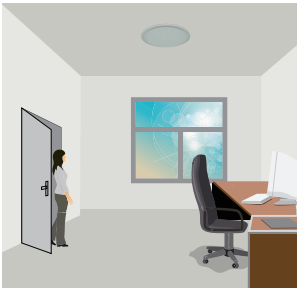

With sufficient natural light, the light does not switch on when presence is detected.

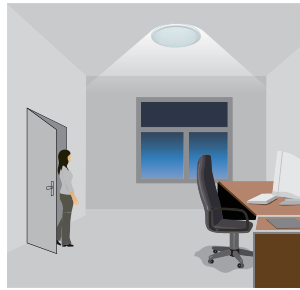

With insufficient natural light, the sensor switches on the light automatically when presence is detected.

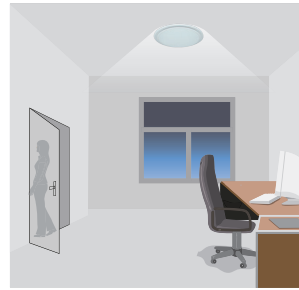

After hold-time, the light dims to stand-by level if the surrounding natural light is below the daylight threshold.



Light switches off automatically after the stand-by period elapses.

### 24h Daylight Monitoring Function

Our innovative and patented software enables our antenna with built-in daylight sensor to provide a "smart photocell" function. This function is activated when stand-by period is set to "+∞".

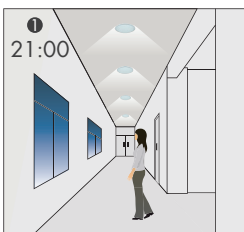

The light switches on at 100% when there is movement detected.

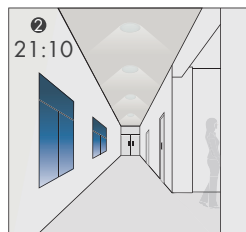

The light dims to stand-by level after the hold-time.

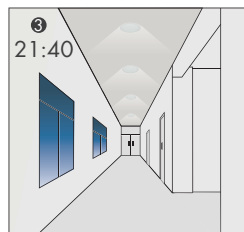

The light remains in dimming level at night.

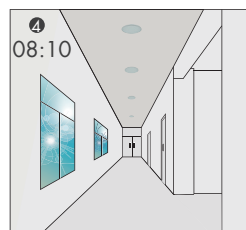
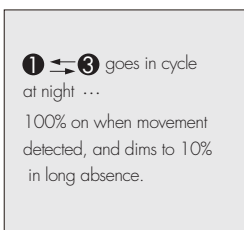

The light turns off completely when natural light lux exceeds daylight threshold pre-set.



The light automatically turns on at 10% when natural light is insufficient (no motion).

#### Settings on this demonstration:

Hold-time: 10min  
Daylight threshold: 50lux  
Stand-by dimming level: 10%  
Stand-by period: +∞

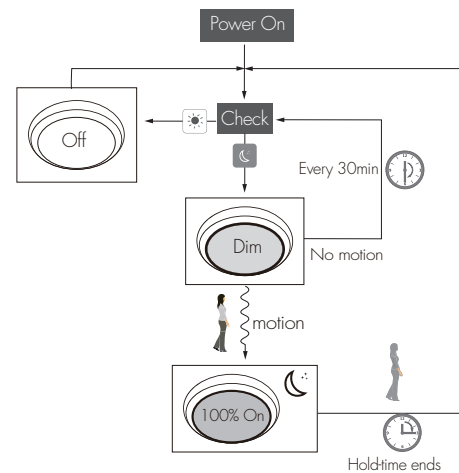

### Manual Override

This sensor reserves the access of manual override function for end-user to switch on/off, or adjust the brightness by push-switch, which makes the product more user-friendly and offers more options to fit some extra-ordinary demands:

- \* Short Push (< 1 s): on/off function;
  - On → Off: the light turns off immediately and cannot be triggered ON by motion until the expiration of pre-set hold-time. After this period, the sensor goes back to normal sensor mode.
  - Off → On: the light turns on and goes to sensor mode, no matter if ambient Lux level exceeds the daylight threshold or not.
- \* Long Push (> 1 s): adjust the hold-time brightness level between 10% and 100%.

Note: if end-user do not want this manual override function, just leave the "push" terminal unconnected to any wire.

### Semi-auto Mode (Absence Detection)

It is easy to forget to switch off the light, in office, corridor, even at home. And in many other cases, people do not want to have a sensor to switch on the light automatically, for example, when people just quickly pass-by, there is no need to have the light on. The solution is to apply this "absence detector": motion sensor is employed, but only activated on the manual press of the push switch, the light keeps being ON in the presence, and dims down in the absence, and eventually switches off in the long absence.

This is a good combination of sensor automation and manual override control, to have the maximum energy saving, and at the same time, to keep efficient and comfortable lighting.



The light does not switch on when there is presence being detected.



Short push to activate the sensor and switch on the light

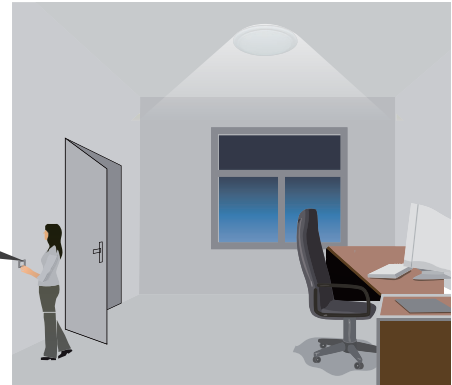

The light turns on full, and the sensor stays in sensor mode.

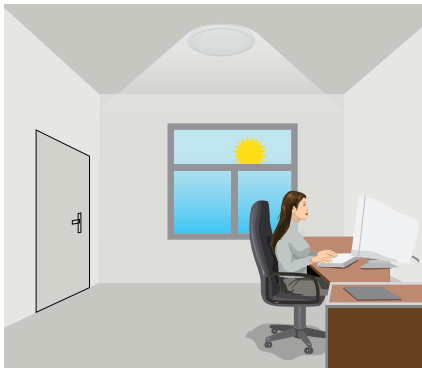

The light keeps being ON during the presence.

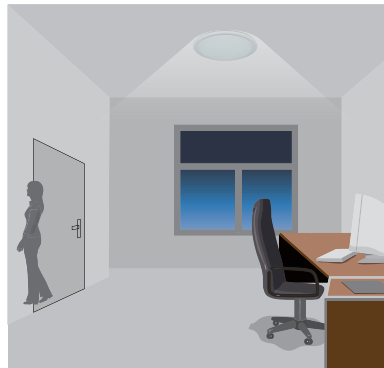

People left, the light dims to stand-by level after the hold-time.



The light switches off automatically after the stand-by period elapses.

Note: end-user can choose either manual override or semi-auto mode for the application. Default mode is manual override.



### **ON/OFF** Permanent ON/OFF function

Press the "ON/OFF" button, the light goes to permanent on or permanent off mode, and the sensor is disabled.

\* Press "Auto Mode", "RESET" or "Scene mode" buttons to quit this mode.

### **Auto Mode** Sensor mode

Press "Auto Mode" button, the sensor starts to function and all settings remain the same as the latest status before the light is switched on/off.

### **RESET** Reset function

Press "RESET" button, all settings go back to default settings.

### **+** **-** Dim +/-

Long press "Dim +" or "Dim -" to adjust the light brightness during hold-time. "+" means dimming up, "-" means dimming down.

### **TEST 2S** Test mode

This button is for testing purpose only. The sensor goes to test mode (hold-time is 2s) after commissioning, meanwhile the stand-by period and daylight sensor are disabled.

\* This mode can be ended by pressing "reset", or any button of "scene mode" and "hold-time". The sensor settings are changed accordingly.

### **Power 100%** **Power 80%** Power output

By pressing these two buttons, the output shifts between 80% (at initial 10,000 hours) and 100%, for energy saving purpose.

### **Ambient Daylight Sensor** Ambient daylight threshold

Press this button, the latest surrounding lux value overwrites the previous lux value learned, and it is set as the daylight threshold. This feature enables the fixture to function well in any real application circumstances.

### **LUX Disable** Lux disable

Press this button, the built-in daylight sensor stops working, and all motion detected could turn on the lighting fixture, no matter how bright the natural light is.

### **M/A** Manual override / Semi-auto mode (absence detection)

By pressing this button, the sensor goes to manual override or Semi-auto mode (absence detection) function.

\* The buzzer beeps twice if it's manual override function, and beeps once if it shifts to Semi-auto mode (absence detection).

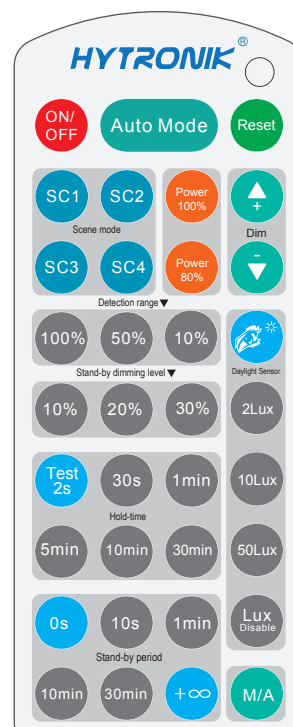

HRC-05

Note: the buzzer beeps one time when RC receives signal successfully.

## Scene mode

There are 4 scene modes fixed program built in the remote control to choose for different applications:

Scene options	Detection range	Hold-time	Stand-by period	Stand-by dimming level	Daylight sensor
SC1	100%	1min	10min	10%	2Lux
SC2	100%	5min	10min	10%	2Lux
SC3	100%	10min	30min	10%	10Lux
SC4	100%	10min	+∞	10%	50Lux

\* End-user can adjust the settings by pressing buttons of detection range/hold-time/stand-by period/stand-by dimming level/daylight sensor. The last setting stays in validity.

### Detection range

Press the buttons of "detection range" to set detection range at 10% /50% /100%.

### Hold-time

Press the buttons of "hold-time" to set hold-time at 30s / 1min / 5min / 10min / 30min.

### Daylight sensor

Press the buttons of "daylight sensor" to set daylight threshold at 2Lux / 10Lux / 50Lux.

### Stand-by period (corridor function)

Press the buttons of "stand-by period" to set stand-by period at 0s / 10s / 1min / 10min / 30min / +∞.

\* "0s" means on/off control; "+∞" means bi-level dimming control, the fixture never switches off when daylight sensor is disabled.

### Stand-by dimming level

Press the buttons of "stand-by dimming level" to set the stand-by dimming level at 10% / 20% / 30%.