

HED1025 / HED1045 / HED1050H / HED1050L / HED1080H



Applications

With both linear and compact versions supporting DALI, 1-10V and Switch-Dim, or controlled by a versatile range of antenna options, the Hex-Drive range lends itself to almost any application!

Suitable for LED panels - insulated terminal cover with cable restraint:

- Office / Commercial Lighting
- Health Care
- Classrooms
- Low-bay warehouse

Use for retrofit upgrades & new luminaire designs.



Features

- with DALI Feedback
 - 1-10V
 - Switch-Dim with Synchronization
 - Stand-by Power Consumption
 - Active PFC Design
 - Configurable Constant Current (CC) Output via Dip-Switch
 - Analogue Flicker-free Dimming
 - Logarithmic Dimming with Multiple Dimming Inputs:
 - Intelligent Thermal Management
 - Thermal Cut-out Protection
 - Short Circuit Protection
 - Over-load Protection
 - Permanent Settings Memory, Protected against Loss of Power
 - 5 Year, 50,000hr Warranty
- } All with Auto-restart

Direct-to-driver occupancy and daylight controls:



For specific features relating to the available sensors, please refer to the relevant sections of this datasheet

Output Configuration

HED1025, 1x25W

700mA	●●●●
675mA	○●●●
650mA	○●●○
625mA	○●●○
600mA	○●●○
575mA	○●●○
550mA	○●●○
525mA	○●●○
500mA	○●●○
475mA	○●●○
450mA	○●●○
425mA	○●●○
400mA	○●●○
375mA	○●●○
350mA	○●●○
325mA	○●●○
	1 2 3 4

HED1045, 1x45W

1400mA	●●●●●●
1200mA	●●●●●○
1050mA	●●●●○●
900mA	●●●●○●
700mA	●●●○●○
500mA	○●●○●○
	1 2 3 4 5

HED1050H, 1x50W

1200mA	●●●●●●
1150mA	○●●●●●
1100mA	○●●●●●
1050mA	○●●●●●
1000mA	○●●●●●
950mA	○●●●●●
900mA	○●●●●●
850mA	○●●●●●
800mA	○●●●●●
750mA	○●●●●●
700mA	○●●●●●
650mA	○●●●●●
600mA	○●●●●●
550mA	○●●●●●
500mA	○●●●●●
	1 2 3 4 5

HED1050L, 1x50W

600mA	●●●●●●
575mA	○●●●●●
550mA	○●●●●●
525mA	○●●●●●
500mA	○●●●●●
475mA	○●●●●●
450mA	○●●●●●
425mA	○●●●●●
400mA	○●●●●●
375mA	○●●●●●
350mA	○●●●●●
325mA	○●●●●●
300mA	○●●●●●
275mA	○●●●●●
250mA	○●●●●●
225mA	○●●●●●
	1 2 3 4 5

HED1080H, 1x80W

1650mA	●●●●●●
1600mA	○●●●●●
1550mA	○●●●●●
1500mA	○●●●●●
1450mA	○●●●●●
1400mA	○●●●●●
1350mA	○●●●●●
1300mA	○●●●●●
1250mA	○●●●●●
1200mA	○●●●●●
1150mA	○●●●●●
1100mA	○●●●●●
1050mA	○●●●●●
1000mA	○●●●●●
950mA	○●●●●●
900mA	○●●●●●
	1 2 3 4 5

Warning: Please make sure the correct current is selected before starting the driver!

Technical Data

Model No.	HED1025	HED1045	HED1050H	HED1050L	HED1080H	
Input	Mains Voltage	220~240VAC 50/60Hz				
	Mains Current	0.15~0.13A	0.22~0.2A	0.3~0.25A	0.3~0.25A	0.45~0.4A
	Power Factor	0.9	0.95	0.95	0.96	0.95
	Max. Efficiency	88%				
	Dielectric Strength	Input→Output : 3000VAC				
	Leakage Current	< 0.25mA				
Output	Ripple Current	<3%	<3%	<3%	<3%	<3%
	Uout Max.	90V	75V	110V	200V	120V
	Turn-on Time	< 0.5s	< 0.5s	< 0.5s	< 0.5s	< 0.5s
	Dimming Interface	DALI, Switch-Dim	DALI, 1-10V, Switch-Dim			
Environment	Operation Temp.	Ta: -20~+50°C	Ta: -20~+45°C	Ta: -20~+50°C	Ta: -20~+50°C	Ta: -20~+50°C
	Case Temp. (Max.)	80°C	85°C	80°C	80°C	80°C
	IP Rating	IP20				
Safety and EMC	EMC Standard	EN55015, EN61547, EN61000-3-2, EN61000-3-3				
	Safety Standard	EN61347-1, EN62493, EN61347-2-13				
	DALI Standard	IEC62386-101 ; IEC62386-102 ; IEC62386-207				
	Certifications	Semko, CB, SAA, CE , EMC				

Model No.	Max. output power/current/voltage range			
HED1025	19.5W/ 325mA /12~60V	21W/ 350mA /12~60V	22.5W/ 375mA /12~60V	24W/ 400mA /12~60V
	25.5W/ 425mA /12~60V	27W/ 450mA /12~60V	26W/ 475mA /12~55V	27.5W/ 500mA /12~55V
	26W/ 525mA /12~50V	27.5W/ 550mA /12~50V	26W/ 575mA /12~45V	27W/ 600mA /12~45V
	28W/ 625mA /12~45V	28W/ 650mA /12~43V	27W/ 675mA /12~40V	28W/ 700mA /12~40V
HED1045	28W/ 500mA /12~56V	40W/ 700mA /12~56V	45W/ 900mA /12~50V	45W/ 1050mA /12~42V
	40W/ 1200mA /12~34V	40W/ 1400mA /12~28V		
HED1050H	40W/ 500mA /12~80V	44W/ 550mA /12~80V	49W/ 600mA /12~80V	49W/ 650mA /12~75V
	49W/700mA /12~70V	50W/ 750mA /12~66V	50W/ 800mA /12~62V	50W/ 850mA /12~59V
	49W/ 900mA /12~55V	49W/ 950mA /12~53V	50W/ 1000mA /12~50V	50W/ 1050mA /12~47V
	50W/ 1100mA /12~45V	50W/ 1150mA /12~43V	50W/ 1200mA /12~42V	
HED1050L	34W/225mA /36~150V	38W/ 250mA /36~150V	41W/ 275mA /36~150V	45W/ 300mA /36~150V
	49W/325mA /36~150V	50W/ 350mA /36~140V	50W/ 375mA /36~130V	50W/ 400mA /36~125V
	50W/ 425mA /36~115V	50W/ 450mA /36~110V	50W/ 475mA /36~105V	50W/ 500mA /36~100V
	50W/ 525mA /36~95V	50W/ 550mA /36~90V	50W/ 575mA /36~86V	50W/ 600mA /36~83V
HED1080H	67W/900mA /16~75V	71W/ 950mA /16~75V	75W/ 1000mA /16~75V	78W/ 1050mA /16~74V
	79W/ 1100mA /16~72V	80W/ 1150mA /16~70V	80W/ 1200mA /16~66V	80W/ 1250mA /16~64V
	80W/ 1300mA /16~61V	80W/ 1350mA /16~59V	80W/ 1400mA /16~57V	80W/ 1450mA /16~55V
	80W/1500mA /16~53V	80W/ 1550mA /16~51V	80W/ 1600mA /16~50V	80W/ 1650mA /16~48V

Dimensions and Terminals

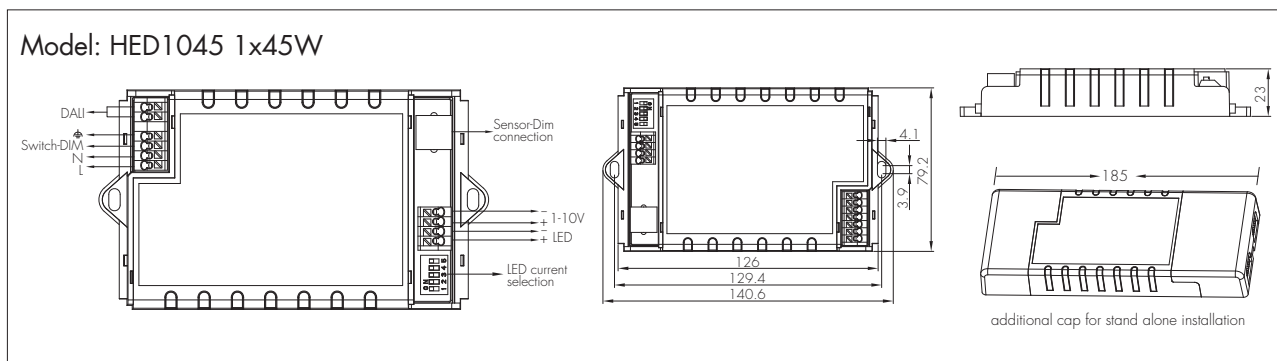
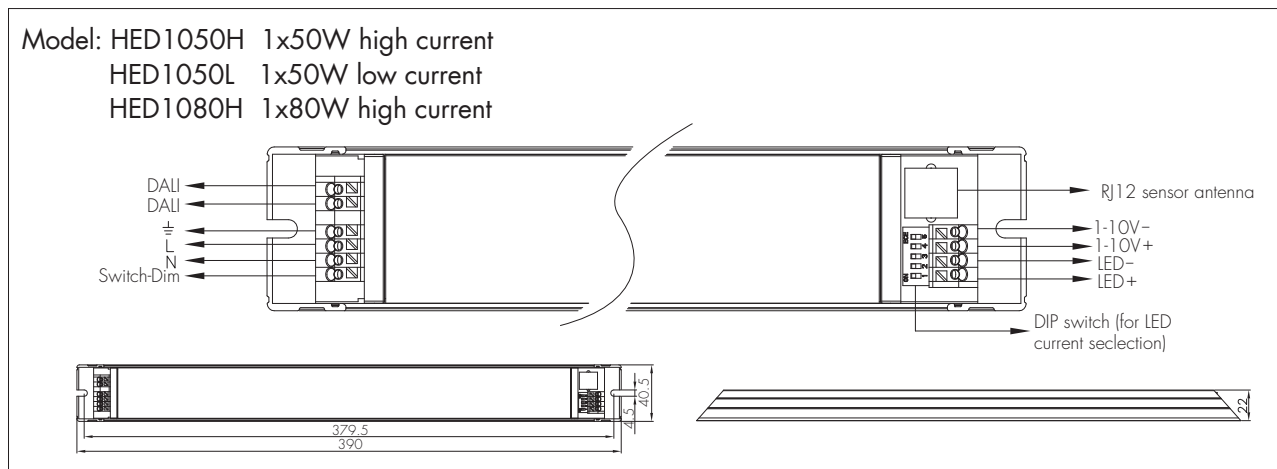
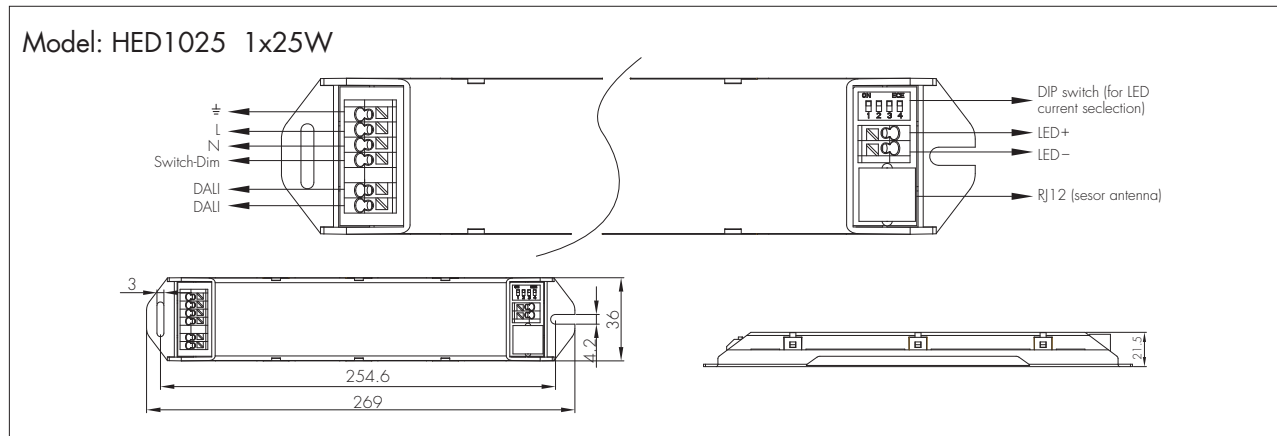

Wire Preparation

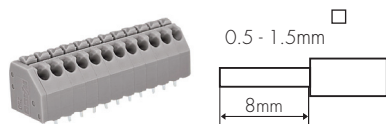

To make or release the wire from the terminal, use a screwdriver to push down the button.

Loading and In-rush Current

Model	HED1025	HED1045	HED1050H	HED1050L	HED1080H
In-rush Current (I _{max.})	3.8A	5.8A	25.8A	25.8A	25.8A
Pulse Time	100 μs	75 μs	350 μs	380 μs	380 μs

Number of Drivers Based upon 16A Circuit Breaker

Cct Breaker Type	HED1025	HED1045	HED1050H	HED1050L	HED1080H
Type B	65	30	20	20	16
Type C	105	50	40	40	30

Wiring Diagrams

Switch-Dim Connections

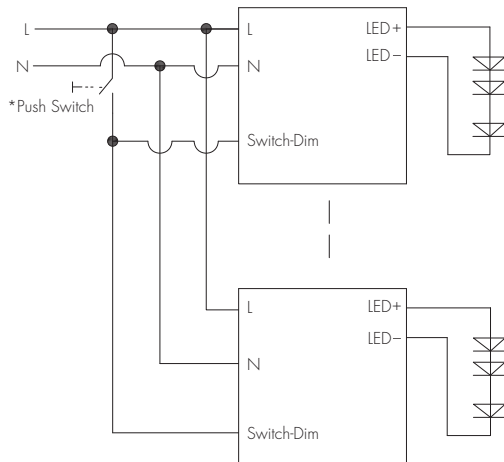

1-10V Connections

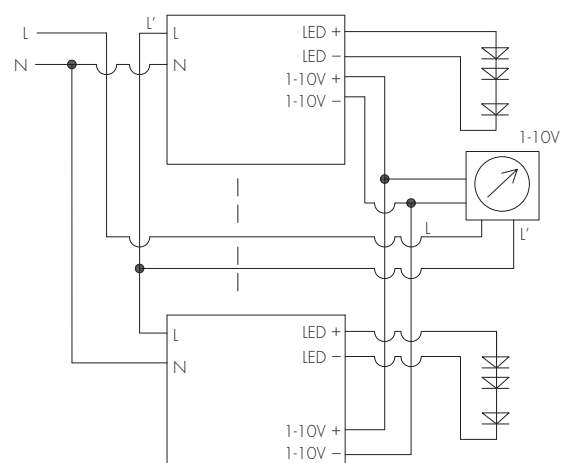

DALI Connections

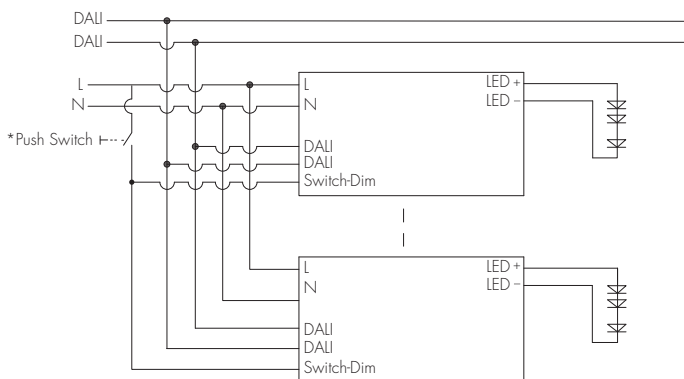

*Optional Switch-Dim for manual over-ride of DALI.
1-10V may NOT be used for manual over-ride of DALI

Antenna Connections (with optional Switch-Dim)

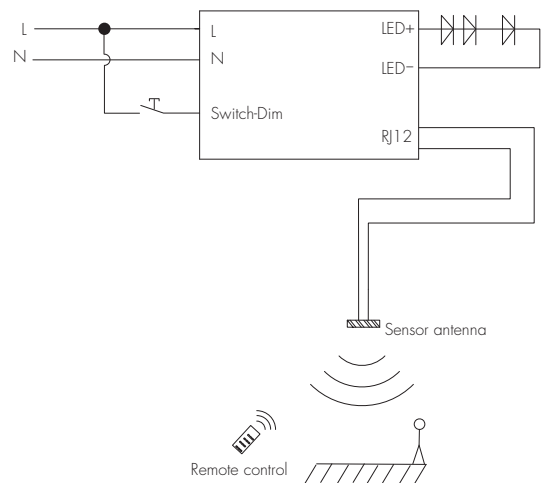

Note: 1. Unused terminals have been omitted for clarity.

2. If connecting an antenna, the DALI and 1-10V inputs are disabled. Please refer to the relevant section in this datasheet for details.

Performance Characteristics

HED1025

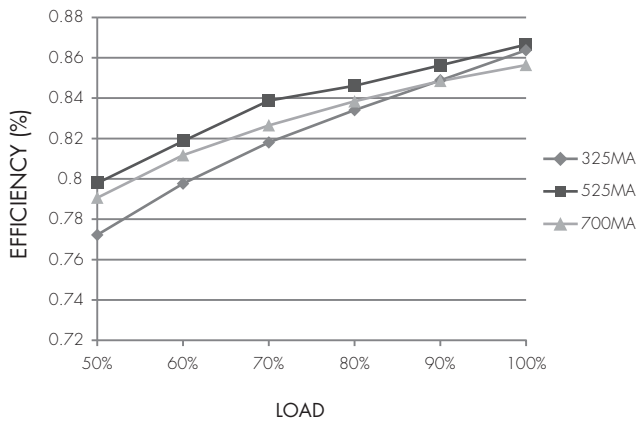

* Typical Efficiency vs Load

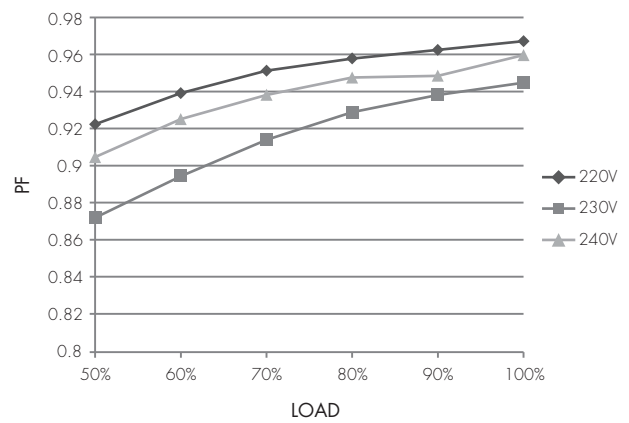

* Typical Power Factor vs Load

HED1045

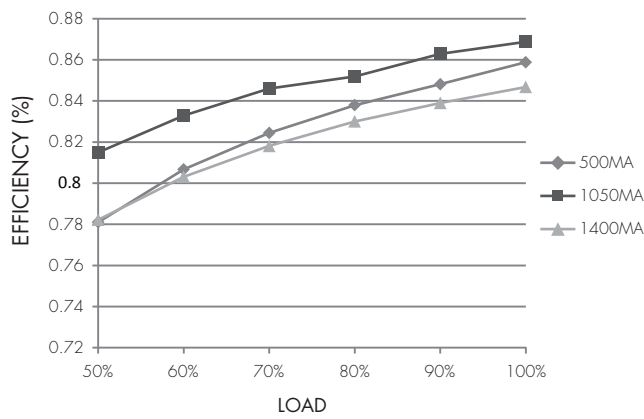

* Typical Efficiency vs Load

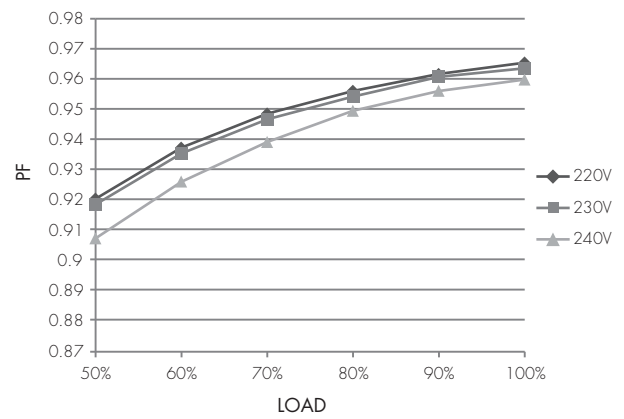

* Typical Power Factor vs Load

HED1050H

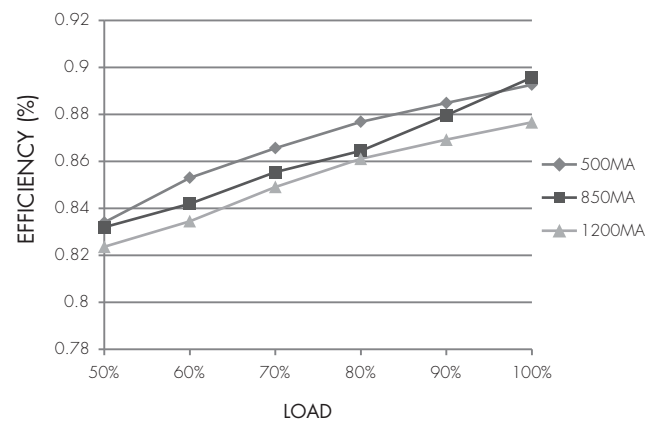

* Typical Efficiency vs Load

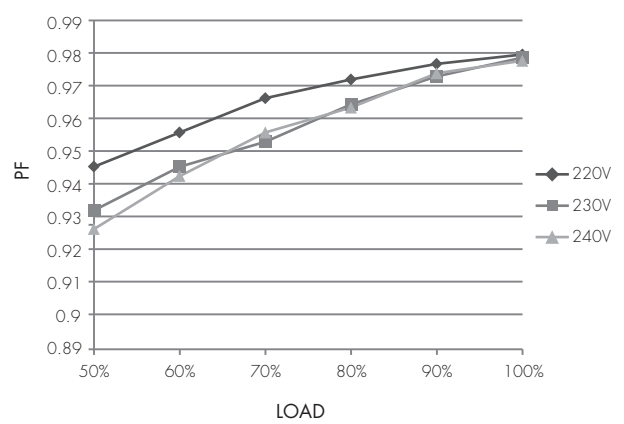

* Typical Power Factor vs Load

HED1050L

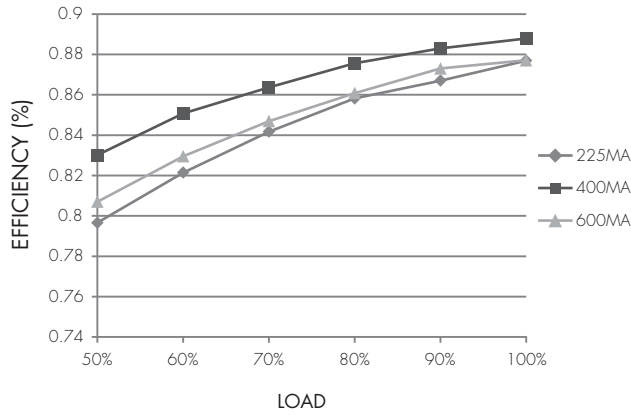

* Typical Efficiency vs Load

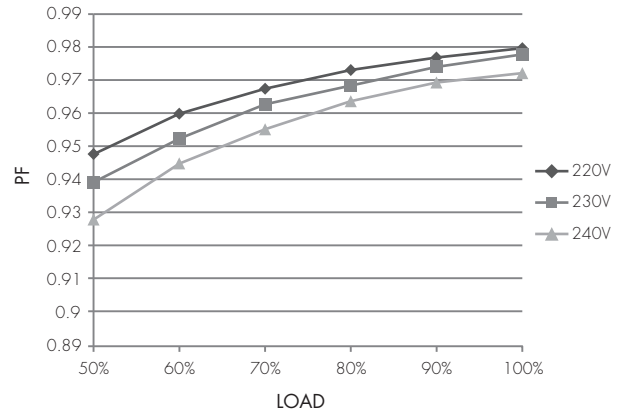

* Typical Power Factor vs Load

HED1080H

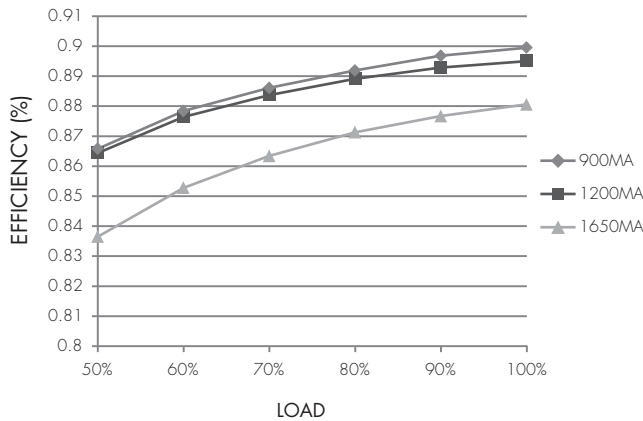

* Typical Efficiency vs Load

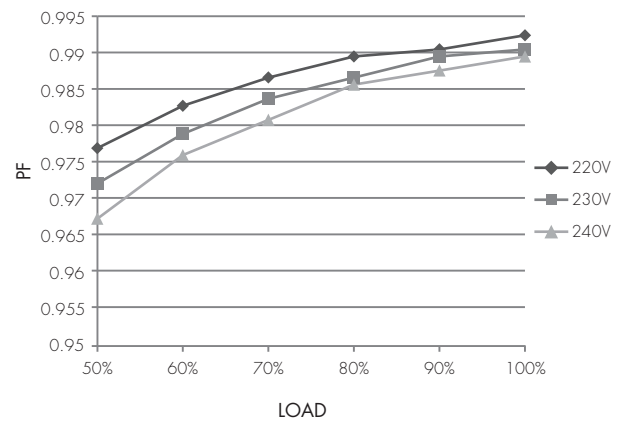

* Typical Power Factor vs Load

Dimming Characteristics

DAI Dimming Curve

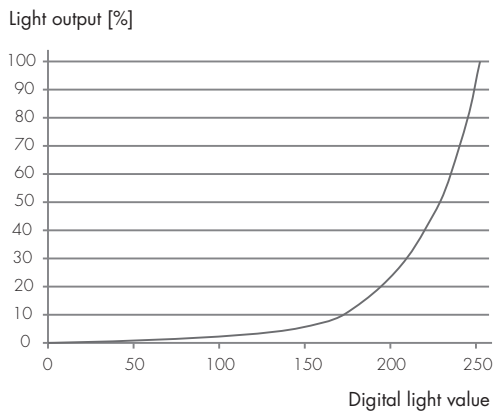

Switch-Dim Dimming Curve

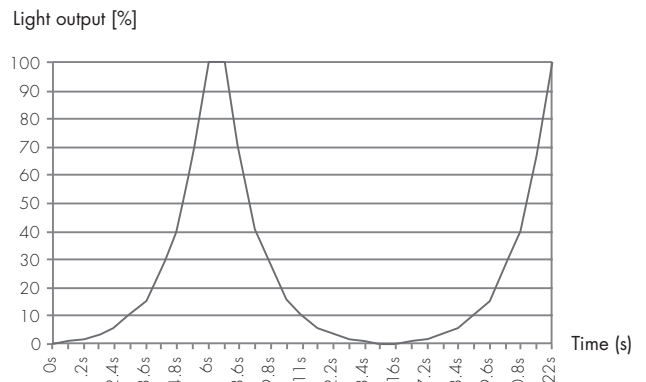

1-10V Dimming Curve

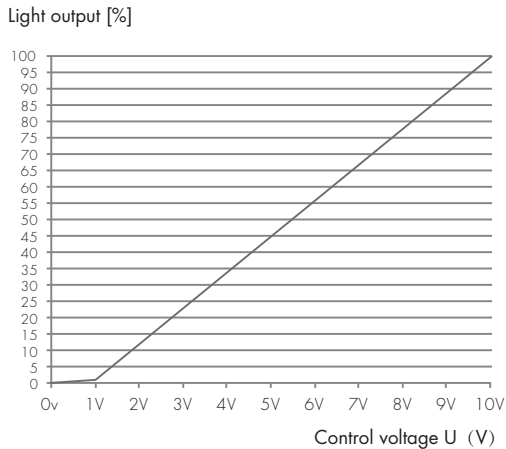

Dimming Profile

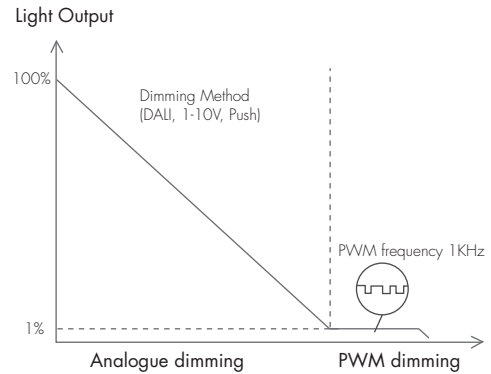

Dimming range	Dimming technique
1%-100%	Analogue
1%	PWM

Dimming Interface Operation Notes

DALI

This series of products are supplied as DALI default group 0 and are 'plug n'play DALI' or 'independent DALI' system ready. These models are also fully DALI addressable and may be assigned to groups within the limits specified by the DALI protocol or supporting DALI controllers by using a DALI programming tool.

Switch-Dim

The provided Switch-Dim interface allows a simple dimming method using commercially available non-latching (momentary) wall switches. Up to 64 LED drivers may be connected to one switch. The Switch-Dim interface may also be used at the same time as DALI to serve as a manual override.

Switch Action
 Short press (<1 second)
 Long press (>1 second)

Response
 Toggle light on / off
 Toggle dim light / increase brightness

Synchronization

Switch Action
 Long press (>15 seconds)

Response
 All lights will dim down to minimum and then return to 50% brightness

1-10V

The 1-10V input is operable via commercially available simple rotary wall switches designed for 1-10V dimming equipment or from dedicated system central dimming controllers.

Note: In the unlikely event that the LED driver be used with the Switch-Dim or DALI interface prior to using the 1-10V interface, the 1-10V interface may need to be re-set. This is achieved by placing a short circuit across the 1-10V terminals until the light returns to full brightness (approx. 3-5 seconds).

Antenna Attachment options

Our range of antenna options allow a very powerful number of 'direct-to-driver' feature options to expand the flexibility of luminaire design. This approach to luminaire design reduces space requirements and component costs whilst simplifying production.

Tri-level Control (Corridor Function)

Options: PIR occupancy detection (HIRO2 / HIRO4)
 Microwave occupancy detection (SAM7 / SAM7/FM)

Wireless Connectivity (RF) with Tri-Level Control

Options: Microwave occupancy detection (SAM8/RC11 / SAM11)

Daylight Harvest

Options: PIR occupancy detection (HIRO1 / HIRO1/FM / HIRO3)



HIRO1 / HIRO2



HIRO3 / HIRO4



HIRO1/FM



SAM7



SAM7/FM



SAM8/RC11



SAM11

PIR Occupancy Detection Pattern

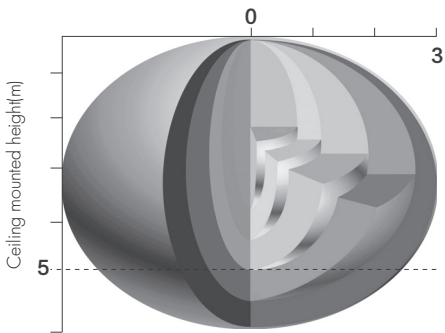

HF Occupancy Detection Pattern

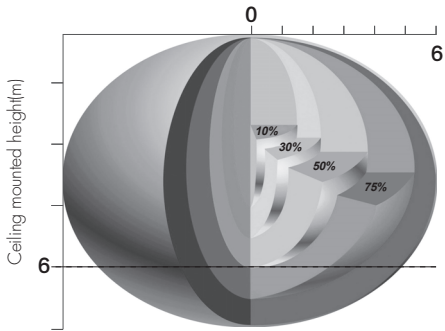

HF Sensor Data	
Sensor principle	High Frequency (microwave)
Operation frequency	5.8GHz +/- 75MHz
Transmission power	<0.2mW
Detection range	Max. (Ø x H) 12m x 6m
Detection angle	30° ~ 150°

HF Sensor & RF Data	
Sensor principle	High Frequency (microwave)
Operation frequency	5.8GHz +/- 75MHz
Transmission power	<0.2mW
Detection range	Max. (Ø x H) 12m x 6m
Detection angle	30° ~ 150°
RF frequency	868MHz (FSK mode)
RF transmission distance	30m indoor, 50m outdoor

PIR Sensor Data	
Sensor principle	PIR Detection
Detection range	Max. (Ø x H) 6m x 5m
Detection angle	360°

Dimensions and Terminals

Tri-level Control (Corridor Function)

PIR Sensor Head
Model HIRO2

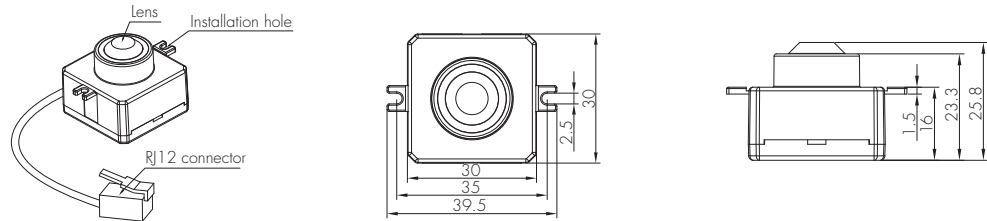

PIR Sensor Head
Model HIRO4

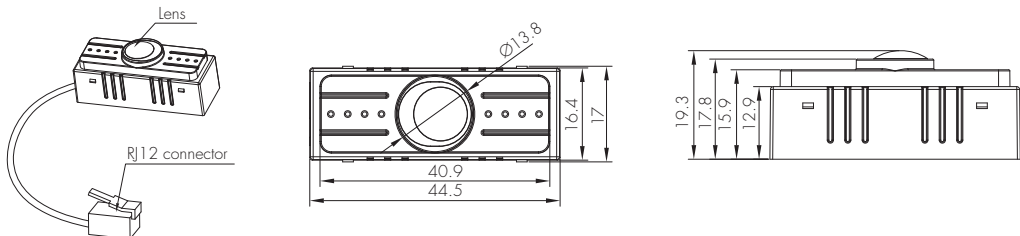

HF sensorDIM™
Model SAM7

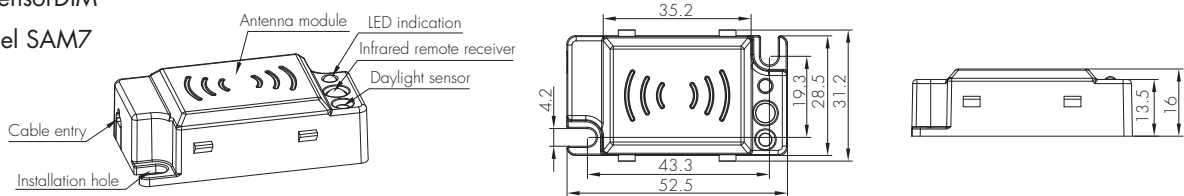

HF sensorDIM™
Model SAM7/FM

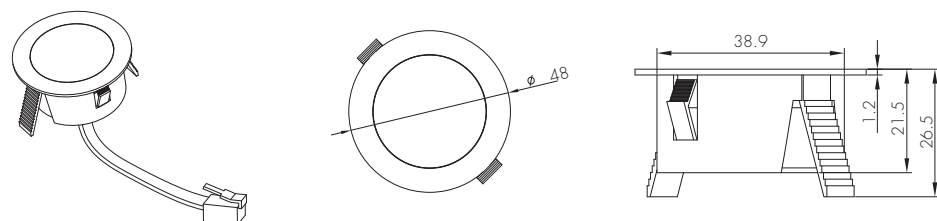

Wireless Connectivity (RF) with Tri-Level Control

HF sensorDIM™

Model SAM11 (RF grouping by rotary switch or remote control)

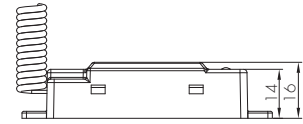
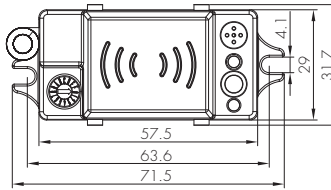
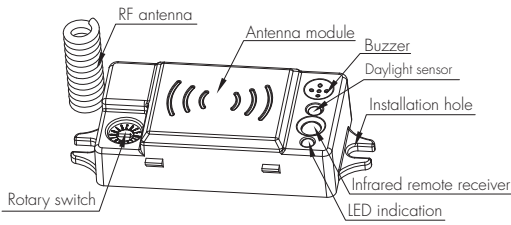

HF sensorDIM™

Model SAM8/RC11 (RF grouping by remote control only)

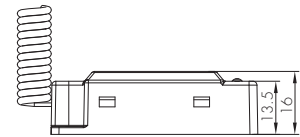
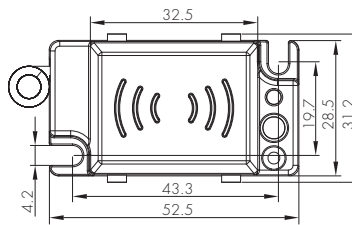
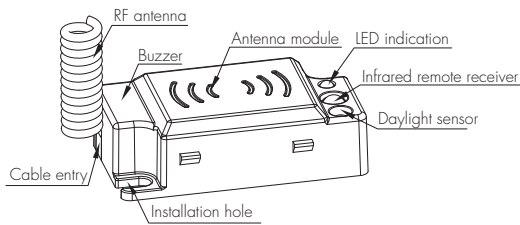

Daylight Harvest

PIR Sensor Head
Model HIRO1

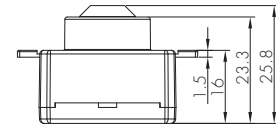
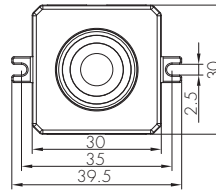
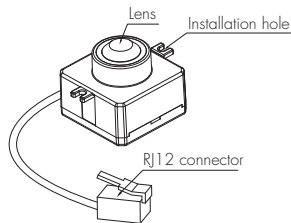

PIR Sensor Head
Model HIRO1/FM

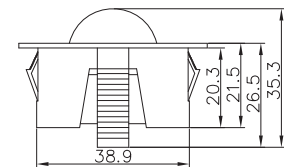
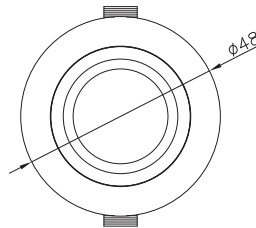
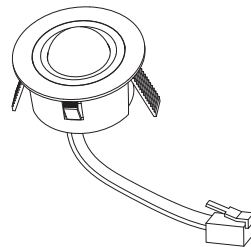

PIR Sensor Head
Model HIRO3

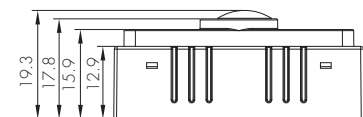
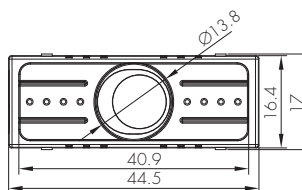
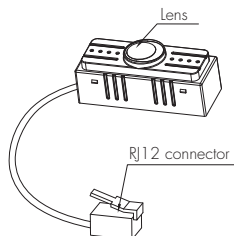

Hytronik builds this function inside the motion sensor to achieve tri-level control, for some areas which require a light change notice before switch-off. The sensor offers 3 levels of light: 100% -> dimmed light (natural light is insufficient) -> off; and 2 periods of selectable waiting time: motion hold-time and stand-by period; Selectable daylight threshold and freedom of detection area.

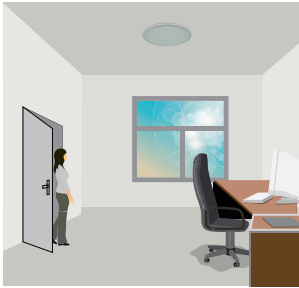

With sufficient natural light, the light does not switch on when presence is detected.

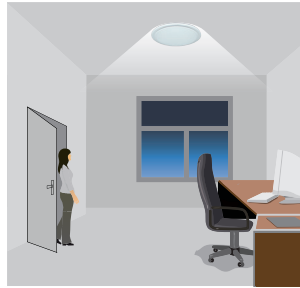

With insufficient natural light, the sensor switches on the light automatically when presence is detected.

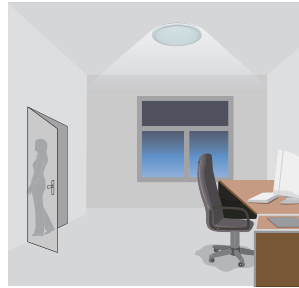

After hold-time, the light dims to stand-by level if the surrounding natural light is below the daylight threshold.



Light switches off automatically after the stand-by period elapses.

24h Daylight Monitoring Function (SAM7 / SAM7/FM only)

Our innovative and patented software enables our antenna with built-in daylight sensor to provide a "smart photocell" function. This function is activated when stand-by period is set to "+∞".

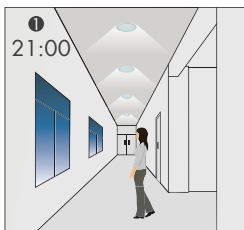

The light switches on at 100% when there is movement detected.

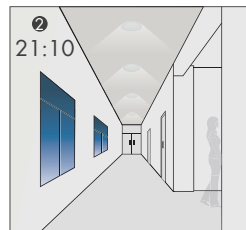

The light dims to stand-by level after the hold-time.

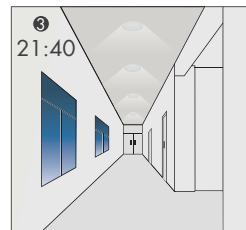

The light remains in dimming level at night.

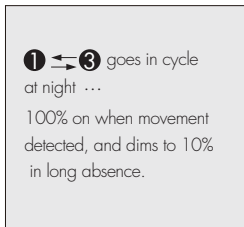

1 ↔ 3 goes in cycle at night ...
100% on when movement detected, and dims to 10% in long absence.

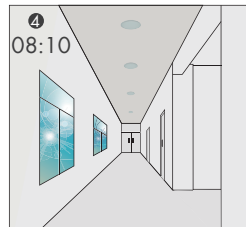

The light turns off completely when natural light lux exceeds daylight threshold pre-set.



The light automatically turns on at 10% when natural light is insufficient (no motion).

Settings on this demonstration:

- Hold-time: 10min
- Daylight threshold: 50lux
- Stand-by dimming level: 10%
- Stand-by period: +∞

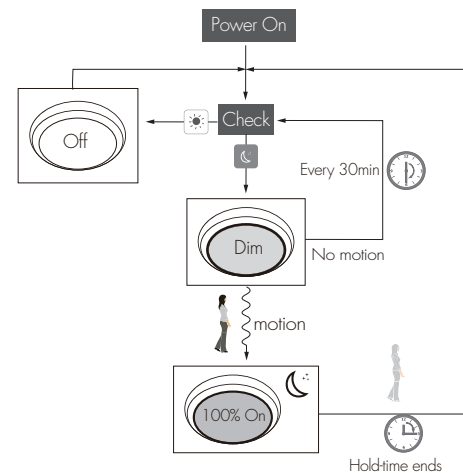

Photocell Advance™ Function (HIRO4 only)

It's well known that LED lights have a totally different spectrum to natural light. Hytronik uses this principle and comes up with special photocell and sophisticated software algorithm to measure and differentiate natural light from LED light, so that this photocell can ignore the LED light and only respond to the natural light.

Our technology has no infringement to the existing patents in the market.

Lux Off Function (HIRO2 / HIRO4 only)

The light turns off automatically whenever surrounding natural light lux level exceeds the daylight threshold for more than 5min, even there is motion detected. However, if the stand-by period is pre-set to infinity "+∞", the light never switches off but stays at dimming level, even when natural light is sufficient .

Manual Override

This sensor reserves the access of manual override function for end-user to switch on/off, or adjust the brightness by push-switch, which makes the product more user-friendly and offers more options to fit some extra-ordinary demands:

* Short Push (< 1s): on/off function;

On → Off: the light turns off immediately and cannot be triggered ON by motion until the expiration of pre-set hold-time. After this period, the sensor goes back to normal sensor mode.

Off → On: the light turns on and goes to sensor mode, no matter if ambient Lux level exceeds the daylight threshold or not.

* Long Push (> 1s): adjust the hold-time brightness level between 10% and 100%.

Note: if end-users do not want this manual override function, just leave the "push" terminal unconnected to any wire.

Semi-auto Mode (Absence Detection)

It is easy to forget to switch off the light, in office, corridor, even at home. And in many other cases, people do not want to have a sensor to switch on the light automatically, for example, when people just quickly pass by, there is no need to have the light on. The solution is to apply this "absence detector": motion sensor is employed, but only activated on the manual press of the push switch, the light keeps being ON in the presence, and dims down in the absence, and eventually switches off in the long absence.

This is a good combination of sensor automation and manual override control, to have the maximum energy saving, and at the same time, to keep efficient and comfortable lighting.

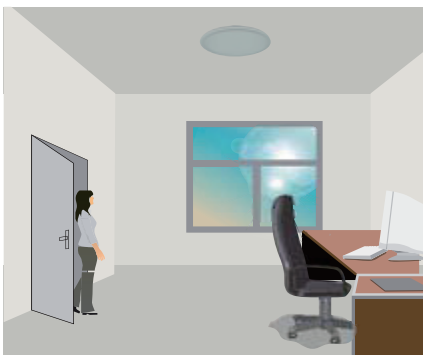

The light does not switch on when there is presence being detected.



Short push to activate the sensor and switch on the light

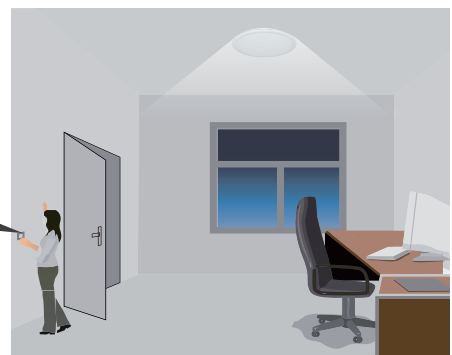

The light turns on full, and the sensor stays in sensor mode.

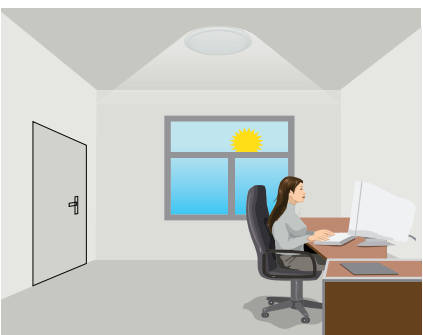

The light keeps being ON during the presence.

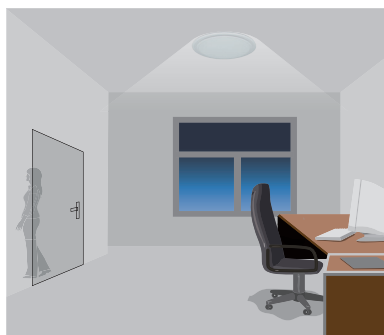

People left, the light dims to stand-by level after the hold-time.



The light switches off automatically after the stand-by period elapses.

Note: end-user can choose either manual override or semi-auto mode for the application. Default mode is manual override.

Settings (Remote Control HRC-11, for HIR04)



Permanent ON/OFF function

Press button "ON/OFF" to select permanent ON or permanent OFF mode.
* Press button "AUTO", "RESET" or "Ambient" to quit this mode.



Reset Settings

Press button "RESET", all settings go back to default values.



Shift Button

Press button "Shift", the LED on the top left corner will flash to indicate mode selection. All values / settings in RED are valid for 20 seconds.



AUTO mode

Press button "AUTO" to initiate automatic mode. The sensor starts working and all settings remain as before the light is switched ON/OFF.



SEMI-AUTO mode

1. Press button "Shift", the red LED flashes for indication.
2. Press button "SEMI-AUTO/AUTO" to initiate semi-auto mode. The fixture is manually turned on by pressing the push-switch, and goes off automatically after stand-by time. (Absence detection mode)

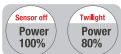

Power output

Press the buttons to select light output at 80% (at initial 10,000 hours) or 100%.
Note: "Sensor off" and "Twilight" functions are disabled.



Brightness +/-

Press these two buttons to adjust the light output brightness during hold-time.



Scene program - 1-key commissioning

1. Press button "Start" to program.
2. Select the buttons in "Detection range", "Daylight threshold", "Hold-time", "Stand-by time", "Stand-by dimming level" to set all parameters.
3. Press button "Memory" to save all the settings programmed in the remote control.
4. Press button "Apply" to set the settings to each sensor unit(s).

For example, to set detection range 100%, daylight threshold Disable, hold-time 5min, stand-by time +∞, stand-by dimming level 30%, the steps should be:

Press button "Start", button "100%", "Disable", "Shift", "5min", "Shift", "+∞", "30%", "Memory". By pointing to the sensor unit(s) and pressing "Apply", all settings are passed on the sensor(s).

Detection range

All buttons in this zone are disabled.

Daylight threshold

Press buttons in zone "Daylight threshold" to set daylight sensor at 2Lux / 10Lux / 50Lux / 100Lux / 300Lux / 500Lux / Disable.

Note: To set daylight sensor at 100Lux / 300Lux / 500Lux, press "Shift" button first.

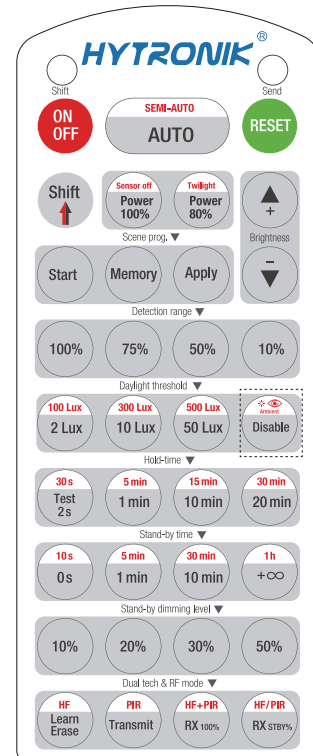

HRC-11

Ambient daylight threshold

1. Press button "Shift", the red LED starts to flash.
2. Press button "Ambient", the surrounding lux level is sampled and set as the new daylight threshold.

Hold-time

Press buttons in zone "hold-time" to set the hold-time at 2s / 30s / 1min / 5min / 10min / 15min / 20min / 30min.

Note: 1. To set hold-time at 30s / 5min / 15min / 30min, press "Shift" button first.

2. 2s is for testing purpose only, stand-by period and daylight sensor settings are disabled in this mode.

* To exit from Test mode, press button "RESET" or any button in "Hold-time".

Stand-by time (corridor function)

Press buttons in zone "stand-by time" to set the stand-by period at 0s / 10s / 1min / 5min / 10min / 30min / 1h / +∞.

Note: "0s" means on/off control; "+∞" means the stand-by time is infinite and the fixture never switches off.

Stand-by dimming level

Press the button in zone "stand-by dimming level" to set the stand-by dimming level at 10% / 20% / 30% / 50%.

Dual tech & RF mode

All buttons in this zone are disabled.

Settings (Remote Control HRC-05, for HIR02 / SAM7 / SAM7/FM)



Permanent ON/OFF function

Press the "ON/OFF" button, the light goes to permanent on or permanent off mode, and the sensor is disabled.

* Press "Auto Mode", "RESET" or "Scene mode" buttons to quit this mode.



Sensor mode

Press "Auto Mode" button, the sensor starts to function and all settings remain the same as the latest status before the light is switched on/off.



Reset function

Press "RESET" button, all settings go back to default settings.



Dim +/-

Long press "Dim +" or "Dim -" to adjust the light brightness during hold-time. "+" means dimming up, "-" means dimming down.



Test mode

This button is for testing purpose only. The sensor goes to test mode (hold-time is 2s) after commissioning, meanwhile the stand-by period and daylight sensor are disabled.

* This mode can be ended by pressing "reset", or any button of "scene mode" and "hold-time". The sensor settings are changed accordingly.

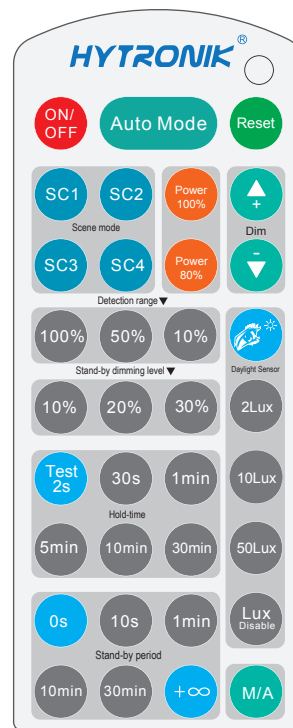

HRC-05

Note: the buzzer beeps one time when RC receives signal successfully.



Power output

By pressing these two buttons, the output shifts between 80% (at initial 10,000 hours) and 100%, for energy saving purpose.



Ambient daylight threshold

Press this button, the latest surrounding lux value overwrites the previous lux value learned, and it is set as the daylight threshold. This feature enables the fixture to function well in any real application circumstances.



Lux disable

Press this button, the built-in daylight sensor stops working, and all motion detected could turn on the lighting fixture, no matter how bright the natural light is.



Manual override / Semi-auto mode (absence detection)

By pressing this button, the sensor goes to manual override or Semi-auto mode (absence detection) function.

* The buzzer beeps twice if it's manual override function, and beeps once if it shifts to Semi-auto mode (absence detection).

Scene mode

There are 4 scene modes fixed program built in the remote control to choose for different applications:

Scene options	Detection range	Hold-time	Stand-by period	Stand-by dimming level	Daylight sensor
SC1	100%	1min	10min	10%	2Lux
SC2	100%	5min	10min	10%	2Lux
SC3	100%	10min	30min	10%	10Lux
SC4	100%	10min	+∞	10%	50Lux

* End-user can adjust the settings by pressing buttons of detection range/hold-time/stand-by period/stand-by dimming level/daylight sensor. The last setting stays in validity.

Detection range

Press the buttons of "detection range" to set detection range at 10% / 50% / 100%.

Note: these buttons are invalid for antenna module HIRO2.

Hold-time

Press the buttons of "hold-time" to set hold-time at 30s / 1min / 5min / 10min / 30min.

Daylight sensor

Press the buttons of "daylight sensor" to set daylight threshold at 2Lux / 10Lux / 50Lux.

Stand-by period (corridor function)

Press the buttons of "stand-by period" to set stand-by period at 0s / 10s / 1min / 10min / 30min / +∞.

* "0s" means on/off control; "+∞" means bi-level dimming control, the fixture never switches off when daylight sensor is disabled.

Stand-by dimming level

Press the buttons of "stand-by dimming level" to set the stand-by dimming level at 10% / 20% / 30%.

The motion detected by the RF sensor antenna SAM8/RC11 or SAM11 will operate all other units programmed on the same group via RF transmission. The transmission can reach 30 meters indoor and 50 meters in open areas. A daylight sensor is also built-in to prevent the light switching on when surrounding natural light is sufficient.

For staircase (SAM8/RC11 or SAM11 serves as both master and slave)

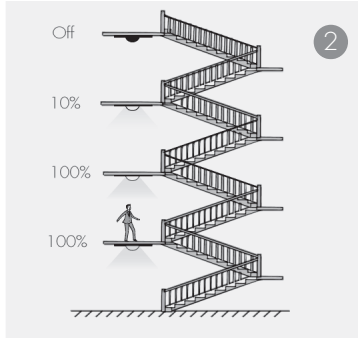
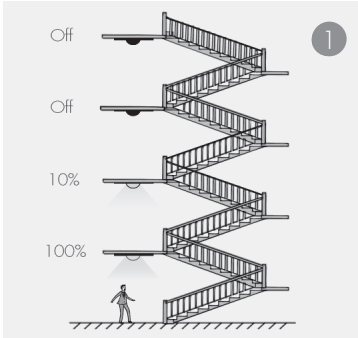

1 The 1st sensor detects motion, it turns the light on 100% and sends signal to the 2nd sensor at the same time. The 2nd light is switched on at stand-by brightness.

2 The person walks to the 2nd floor, the 2nd sensor turns the light on 100%, meanwhile, the 3rd light is switched to stand-by brightness.

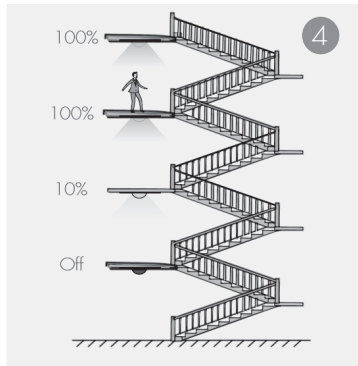
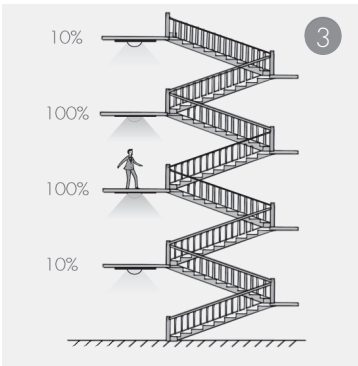

3 The person walks to the 3rd floor, the 3rd sensor turns on the light 100%, meanwhile, the 4th light is switched to stand-by brightness. The 1st light is dimmed to stand-by brightness after hold-time.

4 The person walks to the 4th floor, the 4th sensor turns on the light 100%, meanwhile, the next light is switched to stand-by brightness. The 1st light is off after stand-by period and the 2nd light is dimmed to stand-by brightness.

Tri-level Control (Corridor Function)

Hytronik builds this function inside the motion sensor to achieve tri-level control, for some areas which require a light change notice before switch-off. The sensor offers 3 levels of light: 100%-->dimmed light (natural light is insufficient) -->off; and 2 periods of selectable waiting time: motion hold-time and stand-by period; Selectable daylight threshold and freedom of detection area.

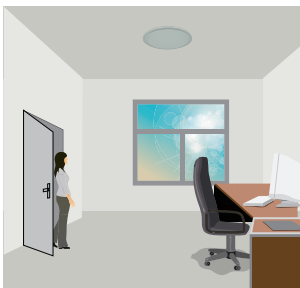

With sufficient natural light, the light does not switch on when presence is detected.

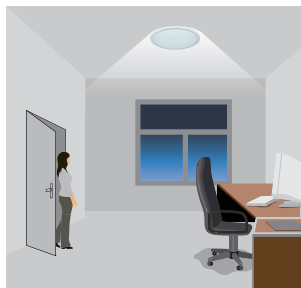

With insufficient natural light, the sensor switches on the light automatically when presence is detected.

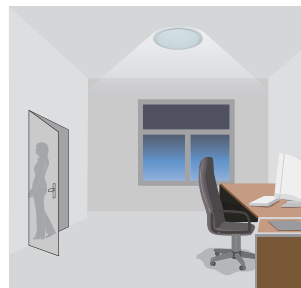

After hold-time, the light dims to stand-by level if the surrounding natural light is below the daylight threshold.



Light switches off automatically after the stand-by period elapses.

24h Daylight Monitoring Function

Our innovative and patented software enables our antenna with built-in daylight sensor to provide a "smart photocell" function. This function is activated when stand-by period is set to "+∞".

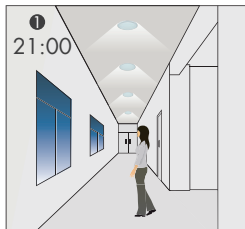

1
21:00
The light switches on at 100% when there is movement detected.

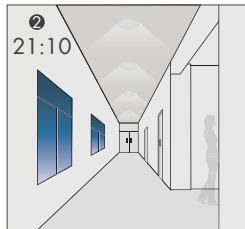

2
21:10
The light dims to stand-by level after the hold-time.



3
21:40
The light remains in dimming level at night.

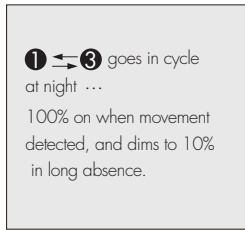

1 ↔ 3 goes in cycle at night ...
100% on when movement detected, and dims to 10% in long absence.



4
08:10
The light turns off completely when natural light lux exceeds daylight threshold pre-set.

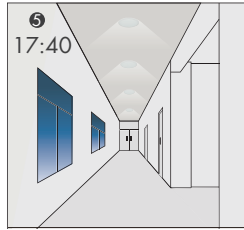

5
17:40
The light automatically turns on at 10% when natural light is insufficient (no motion).

Settings on this demonstration:

Hold-time: 10min
Daylight threshold: 50lux
Stand-by dimming level: 10%
Stand-by period: +∞

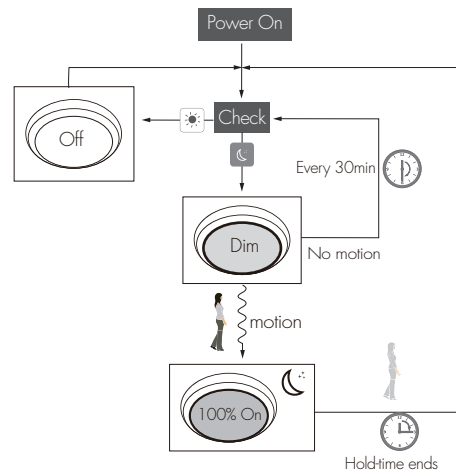

Manual Override

This sensor reserves the access of manual override function for end-user to switch on/off, or adjust the brightness by push-switch, which makes the product more user-friendly and offers more options to fit some extra-ordinary demands:

* Short Push (< 1 s): on/off function;

On → Off: the light turns off immediately and cannot be triggered ON by motion until the expiration of pre-set hold-time. After this period, the sensor goes back to normal sensor mode.

Off → On: the light turns on and goes to sensor mode, no matter if ambient Lux level exceeds the daylight threshold or not. When manually push on the master via the push switch, it sends out the RF "ON" signal to all slaves in the same group. The slave only turns on the light when ambient light is insufficient.

* Long Push (> 1 s): adjust the hold-time brightness level between 10% and 100%.

Note: if end-users do not want this manual override function, just leave the "push" terminal unconnected to any wire.

RF Grouping via Rotary Switch (for SAM11 only)

By selecting the same channel on both of the transmitter unit (master) and receiving unit (slave), the grouping is automatically completed. 16 channels (maximum 16 groups) are available for both the master & slave unit.

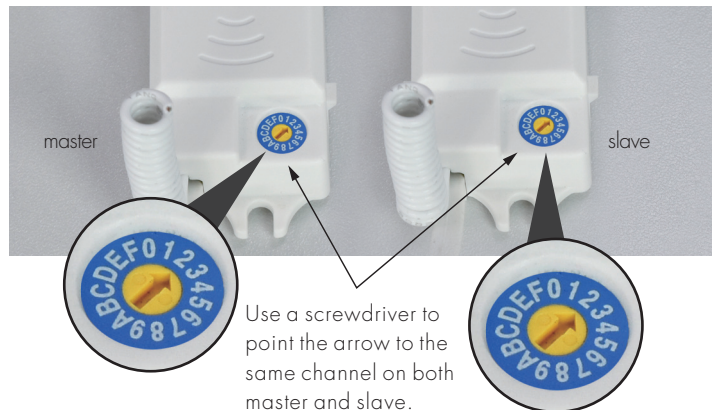

Settings (Remote Control HRC-11)



Permanent ON/OFF function

Press button "ON/OFF" to select permanent ON or permanent OFF mode.
* Press button "AUTO", "RESET" to quit this mode.



Reset Settings

Press button "RESET", all settings go back to default settings.



Shift Button

Press button "Shift", the LED on the top left corner will flash to indicate mode selection. All values / settings in RED are valid for 20 seconds.



AUTO mode

Press button "AUTO" to initiate automatic mode. The sensor starts working and all settings remain as before the light is switched ON/OFF.



SEMI-AUTO mode

First press button "Shift" then "SEMI-AUTO" to initiate semi-auto mode. The fixture is manually on by push-switch and automatically off in this mode.



Power output

Press the buttons to select light output at 80% (at initial 10,000 hours) or 100%.
Note: "Sensor off" and "Twilight" functions are disabled.



Brightness +/-

Press the buttons to adjust the light brightness during hold-time.



Scene program - 1-key commissioning

1. Press button "Start" to program.
2. Select the buttons in "Detection range", "Daylight threshold", "Hold-time", "Stand-by time", "Stand-by dimming level" to set all parameters.
3. Press button "Memory" to save all the settings programmed in the remote control.
4. Press button "Apply" to set the settings to each sensor unit(s).

For example, to set detection range 100%, daylight threshold Disable, hold-time 5min, stand-by time +∞, stand-by dimming level 30%, the steps should be:

Press button "Start", button "100%", "Disable", "Shift", "5min", "Shift", "+∞", "30%", "Memory". By pointing to the sensor unit(s) and pressing "Apply", all settings are passed on the sensor(s).

Detection range (valid for master only)

Press buttons in zone "Detection range" to set detection range at 100% / 75% / 50% / 10%.

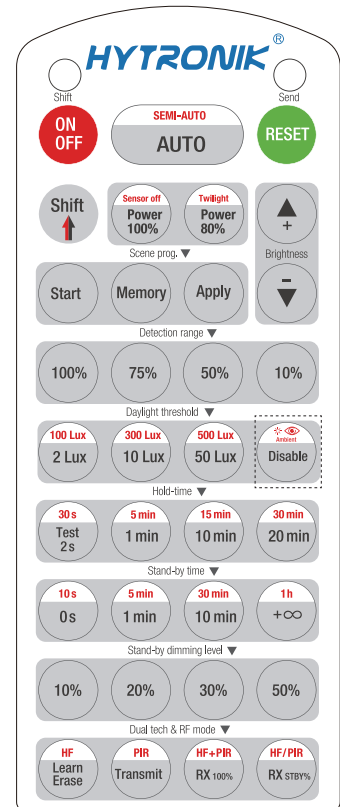

HRC-11

Note: the buzzer beeps one time when RC receives signal successfully.

Daylight threshold

Press buttons in zone "Daylight threshold" to set daylight sensor at 2Lux / 10Lux / 50Lux / 100Lux / 300Lux / 500Lux / Disable.

Note: To set daylight sensor at 100Lux / 300Lux / 500Lux, press "Shift" button first.

Ambient daylight threshold

1. Press button "Shift", the red LED starts to flash.
2. Press button "Ambient", the surrounding lux level is sampled and set as the new daylight threshold.

Hold-time

Press buttons in zone "hold-time" to set the hold-time at 2s / 30s / 1min / 5min / 10min / 15min / 20min / 30min.

Note: 1. To set hold-time at 30s / 5min / 15min / 30min, press "Shift" button first.

2. 2s is for testing purpose only, stand-by period and daylight sensor settings are disabled in this mode.

*To exit from Test mode, press button "RESET" or any button in "Hold-time".

Stand-by time (corridor function)

Press buttons in zone "stand-by time" to set the stand-by period at 0s / 10s / 1min / 5min / 10min / 30min / 1h / +∞.

Note: "0s" means on/off control; "+∞" means bi-level control, if daylight threshold is disabled or natural light is insufficient, the fixture is 100% on when there is motion detected, and remains at the stand-by dimming level after motion hold-time.

Stand-by dimming level

Press the button in zone "stand-by dimming level" to set the stand-by dimming level at 10% / 20% / 30% / 50%.

Dual tech & RF mode

"HF", "PIR", "HF+PIR", "HF/PIR" are disabled.

For RF grouping via remote control, please refer to steps below:

RF grouping by HRC-11

Short press "Learn/Erase" button on RC to activate pairing mode, and the receiver unit starts to beep once every second for 3min.

Note: the unit can only pair up to 30 units.

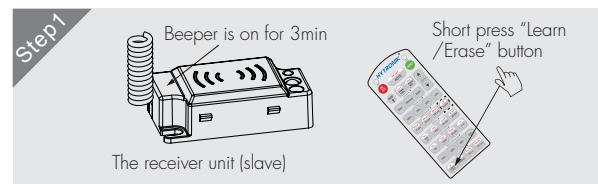

Short press "Transmit" button on RC, the commander unit (master unit) beeps one time to send the transmission signal.

Upon receiving the transmission signal, the receiver unit (slave unit) rapidly beeps 3 times in 1s to indicate the success of pairing. Repeat this step to pair more units.

One more short press on "Learn/Erase" button to the receiver unit to complete the pairing process, the receiver unit will quit the pairing mode.

Note: Press button RX100%, the light on receiver unit is 100% on upon receiving RF on signal; Press "RX STBY%" button, the light(s) goes to preset stand-by dimming level directly.

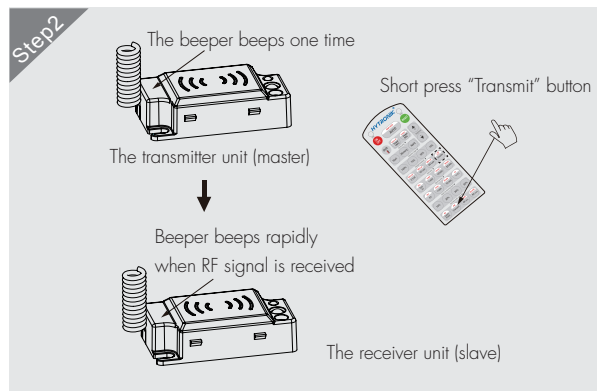

Erase:

Long press "Learn/Erase" button for 3s to the sensor unit. The beeper beeps rapidly for about 5s. All commands received before are erased.



Daylight Harvest



Light will not switch on when natural light is sufficient, even there is motion detected.

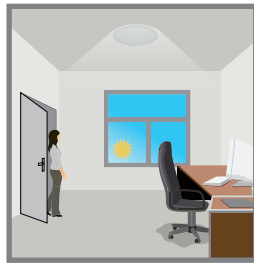

The light switches on automatically with presence when natural light is insufficient.



The light turns on at full or dims to maintain the lux level. The light output regulates according to the level of natural light available.

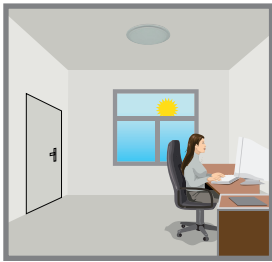

The light switches off when the ambient natural light is sufficient.



The light dims to stand-by period after hold-time and stays on selected minimum dimming level.



The light switches off completely after the stand-by period.

Note:

The light automatically dims down and eventually turns off if the natural light lux level exceeds the daylight threshold. However, if the stand-by period is preset at "+∞", the fixture never switches off but dim to minimum level, even the natural light is sufficient.

Photocell Advance™ Function (HIRO3)

It's well known that LED lights have a totally different spectrum to natural light. Hytronik uses this principle and comes up with special photocell and sophisticated software algorithm to measure and differentiate natural light from LED light, so that this photocell can ignore the LED light and only respond to the natural light.

Our technology has no infringement to the existing patents in the market.

Lux Off Function

The light turns off automatically whenever surrounding natural light lux level exceeds the daylight threshold for more than 5min, even there is motion detected. However, if the stand-by period is pre-set to infinity "+∞", the fixture never switches off but stays at dimming level, even when natural light is sufficient.

Manual Override

This sensor reserves the access of manual override function for end-user to switch on/off, or adjust the target lux level by push-switch, which makes the product more user-friendly and offers more options to fit some extra-ordinary demands:

* Short Push (< 1 s): on/off function;

On → Off: the light turns off immediately and cannot be triggered ON by motion until the expiration of pre-set hold-time. After this period, the sensor goes back to normal sensor mode.

Off → On: the light turns on and goes to sensor mode, no matter if ambient Lux level exceeds the daylight threshold or not.

* Long Push (> 1 s): adjust the target lux level by turning the light up or down. Both the adjustment on RC and push switch can overwrite each other, the last adjustment remains in memory.

Note: if end-users do not want this manual override function, just leave the "push" terminal unconnected to any wire.

Settings (Remote Control HRC-11, for HIR03)

Permanent ON/OFF function

Press button "ON/OFF" to select permanent ON or permanent OFF mode.
* Press button "AUTO", "RESET" or "Ambient" to quit this mode.

Reset Settings

Press button "RESET", all settings go back to default values.

Shift Button

Press button "Shift", the LED on the top left corner will flash to indicate mode selection. All values / settings in RED are valid for 20 seconds.

AUTO mode

Press button "AUTO" to initiate automatic mode. The sensor starts working and all settings remain as before the light is switched ON/OFF.

SEMI-AUTO mode

1. Press button "Shift", the red LED flashes for indication.
2. Press button "SEMI-AUTO/AUTO" to initiate semi-auto mode. The fixture is manually turned on by pressing the push-switch, and goes off automatically after stand-by time. (Absence detection mode)

Power output

Press the buttons to select light output at 80% (at initial 10,000 hours) or 100%.
Note: "Sensor off" and "Twilight" functions are disabled.

Brightness +/-

Press these two buttons to adjust the light output brightness and set a new target lux level. The daylight sensor can measure ambient daylight level and ignore the LED light, so as to calculate how much artificial light is needed to maintain the target lux level.

Scene program - 1-key commissioning

1. Press button "Start" to program.
2. Select the buttons in "Detection range", "Daylight threshold", "Hold-time", "Stand-by time", "Stand-by dimming level" to set all parameters.
3. Press button "Memory" to save all the settings programmed in the remote control.
4. Press button "Apply" to set the settings to each sensor unit(s).
For example, to set detection range 100%, daylight threshold Disable, hold-time 5min, stand-by time +∞, stand-by dimming level 30%, the steps should be:
Press button "Start", button "100%", "Disable", "Shift", "5min", "Shift", "+∞", "30%", "Memory". By pointing to the sensor unit(s) and pressing "Apply", all settings are passed on the sensor(s).

Detection range

Buttons of "detection range" are disabled.

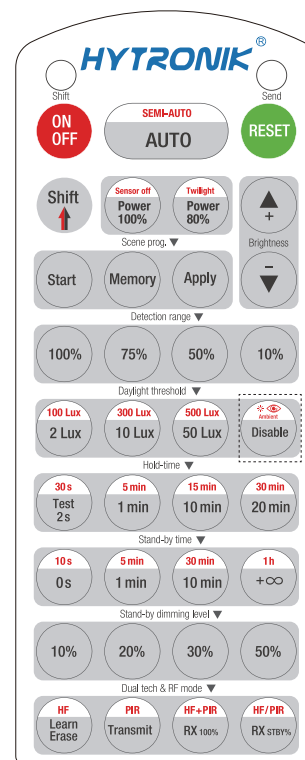

HRC-11

Daylight threshold

Press buttons in zone "Daylight threshold" to set daylight sensor at 2Lux / 10Lux / 50Lux / 100Lux / 300Lux / 500Lux / Disable.
Note: To set daylight sensor at 100Lux / 300Lux / 500Lux, press "Shift" button first.

Ambient daylight threshold

1. Press button "Shift", the red LED starts to flash.
2. Press button "Ambient", the surrounding lux level is sampled and set as the new daylight threshold.

Hold-time

Press buttons in zone "hold-time" to set the hold-time at 2s / 30s / 1min / 5min / 10min / 15min / 20min / 30min.
Note: 1. To set hold-time at 30s / 5min / 15min / 30min, press "Shift" button first.

2. 2s is for testing purpose only, stand-by period and daylight sensor settings are disabled in this mode.

*To exit from Test mode, press button "RESET" or any button in "Hold-time".

Stand-by time (corridor function)

Press buttons in zone "stand-by time" to set the stand-by period at 0s / 10s / 1min / 5min / 10min / 30min / 1h / +∞.
Note: "0s" means on/off control; "+∞" means the stand-by time is infinite and the fixture never switches off.

Stand-by dimming level

Press the button in zone "stand-by dimming level" to set the stand-by dimming level at 10% / 20% / 30% / 50%.

Dual tech & RF mode

All buttons in this zone are disabled.

Settings (Remote Control HRC-01, for HIR01 / HIR01 / FM)



Permanent ON/OFF function

Press the "ON/OFF" button, the light goes to permanent on or permanent off mode, and the sensor is disabled.

* Press "Auto Mode", "RESET" or "Scene mode" buttons to quit this mode.



Sensor mode

Press "Auto Mode" button, the sensor starts to function and all settings remain the same as the latest status before the light is switched on/off.



Reset function

Press "RESET" button, all settings go back to default value (same as scene mode 3):

Detection range: 100%; Hold-time: 5min; Stand-by period: 10min;

Stand-by dimming level: 20%; Constant lux: 100lux



Dim +/-

Press these two buttons to adjust the light output brightness and set a new target lux level. The daylight sensor can measure ambient daylight level and ignore the LED light, so as to calculate how much artificial light is needed to maintain the target lux level.



HRC-01

Note: the buzzer beeps one time when RC receives signal successfully.



Test mode

This button is for testing purpose only. The sensor goes to test mode (hold-time is 2s) after commissioning, meanwhile the stand-by period and daylight sensor are disabled.

* This mode can be ended by pressing "reset", or any button of "scene mode" and "hold-time". The sensor settings are changed accordingly.



8H permanent on mode

In some circumstances, people want to disable the sensor and keep the light on for a certain period of time, even there is no motion detected. This function is built-in the software and can be achieved by pressing the "8H" button on the RC.

* Press "ON/OFF", "Auto Mode", "RESET" or "Scene mode" buttons to quit from this mode.

Scene mode

There are 6 scene modes fixed program built-in the remote control to choose for different applications:

Scene options	Hold-time	Stand-by period	Stand-by dimming level	Constant Lux	Detection range
SC1	1min	1min	10%	50Lux	disabled
SC2	3min	5min	20%	75Lux	disabled
SC3	5min	10min	20%	100Lux	disabled
SC4	10min	30min	30%	150Lux	disabled
SC5	20min	1H	30%	200Lux	disabled
SC6	30min	+∞	50%	400Lux	disabled

* End-user can adjust the settings by pressing buttons of detection range/hold-time/stand-by period/stand-by dimming level/daylight sensor. The last setting stays in validity.

Hold-time

Press the buttons of "hold-time" to set hold-time at 30s / 1min / 5min / 10min / 20min / 30min .

Stand-by period (Corridor function)

Press the buttons of "stand-by period (corridor function)" to set stand-by period at 0s/10s/1min/5min/10min/30min/1H/+∞.

Note: "0s" means on/off control; "+∞" means bi-level dimming control and the fixture never switches off.

Stand-by dimming level

Press the buttons of "stand-by dimming level" to set the stand-by dimming level at 10%/20%/30%/50%.

Detection range

Buttons of "detection range" are disabled.