

## Tri-level Control HF Sensor

HC403VRC-KD HC404VRC-KD  
Detached Version with Daylight Monitoring and Remote Control

# HYTRONIK®

### Applications

Occupancy detector with tri-level dimming control suitable for indoor use.

Suitable for building into the fixture:

- Office / Commercial Lighting
  - Classroom
  - Warehouse
- Use for new luminaire designs and installations



### Features

- 24 hour daylight monitoring dawn/dusk sensor
- Tri-level dimming control based upon occupancy (also known as corridor function)
- 1-10V dimming control method
- One-touch daylight learning via remote control
- Zero crossing detection circuit reduces in-rush current and prolongs relay life
- Loop-in and loop-out terminal for efficient installation
- 5 Year, 50,000hr Warranty

### Technical Data

#### Input Characteristics

Model No.	HC403VRC-KD HC404VRC-KD
Mains voltage	120~277VAC 50/60Hz
Stand-by power	<0.5W
Load ratings:	
Capacitive	400VA @ 120VAC 800VA @ 230VAC 1000VA @ 277VAC
Warming-up	20s

#### Safety and EMC

EMC standard (EMC)	EN55015, EN61000
Safety standard (LVD)	EN60669, AS/NZS60669
Radio Equipment (RED)	EN300440, EN301489, EN62479
Certification	Semko, CB, CE, EMC, RED, SAA

CE emc RED SAA CB IP20

#### Sensor Data

Model No.	SAM5 SAM6 SAM9
Sensor principle	High Frequency (microwave)
Operation frequency	5.8GHz +/- 75MHz
Transmission power	<0.2mW
Detection range:	
SAM5 SAM9	Max. (Ø x H) 8m x 5m
SAM6	Max. (Ø x H) 16m x 15m
Detection angle	30° ~ 150°

#### DIP Switch Settings (HC403VRC-KD):

Sensitivity	10% / 50% / 75% / 100%
Hold-time	5s ~ 30min (selectable)
Daylight threshold	2 ~ 50 lux, disabled
Stand-by period	0s ~ 1h, +∞ (selectable)
Stand-by dimming level	10% / 20% / 30% / 50%

#### Environment

Operation temperature	Ta: -20°C ~ +60°C
Case temperature (Max.)	Tc: +80°C
IP rating	IP20

**Sensor Main Body**  
 HC403VRC-KD (rectangular size)

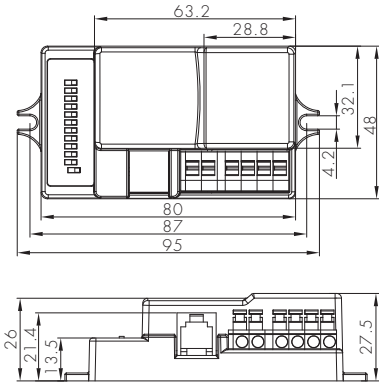
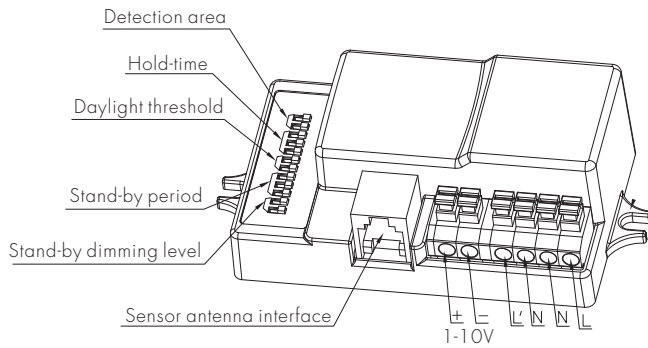

**HC404VRC-KD (linear compact size)**

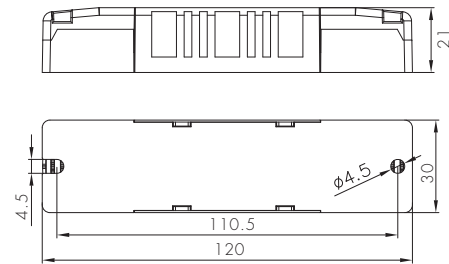
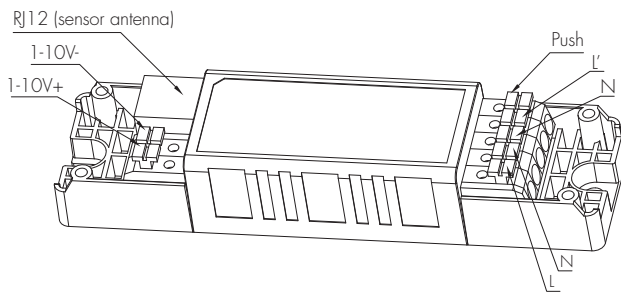

Hytronik offers three sensor antenna modules for different applications:

<p><b>Model SAM5</b></p> <p>Super-compact sensor antenna, with optional cable entry (side entry and back entry).</p>	
<p><b>Model SAM6 (for high bay)</b></p> <p>Flat sensor antenna, with plastic fingers to hook on T5/T8 tubes</p>	
<p><b>Model SAM9</b></p> <p>Basic compact sensor antenna, can not work with remote control.</p>	

## Typical applications:

1. Office light, most of which have aluminium louvres and is impossible for microwave sensors to go through.
2. LED bulkhead or high/low bay, which has limited space and ordinary sensor is too big or too thick to be built in, also easy to cast shadow in the shade.

For linear T5, T8, TC-L lamps



Most of the linear office lights have metal louvre, where microwave cannot penetrate through. An easy alternative solution is to use this detached sensor antenna head, grip on the T5 and T8 tube, and put the sensor main body behind the metal louvre, together with the ballast or driver.

For LED bulkhead

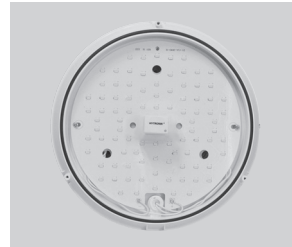

In such applications, only the detached small antenna is needed on the outer surface, while the sensor body and the driver/ballast can be hidden behind the panel. No shadow is cast in the shade.



## Functions and Features

### 1 Tri-level Control (Corridor Function)

Hytronik builds this function inside the motion sensor to achieve tri-level control, for some areas which require a light change notice before switch-off. The sensor offers 3 levels of light: 100%-->dimmed light (natural light is insufficient)-->off; and 2 periods of selectable waiting time: motion hold-time and stand-by period; Selectable daylight threshold and freedom of detection area.

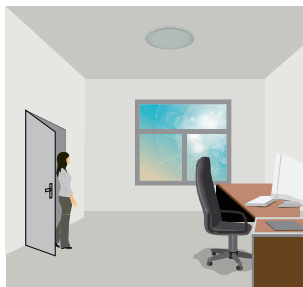

With sufficient natural light, the light does not switch on when presence is detected.

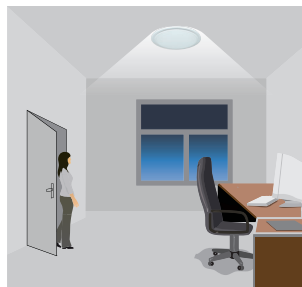

With insufficient natural light, the sensor switches on the light automatically when presence is detected.

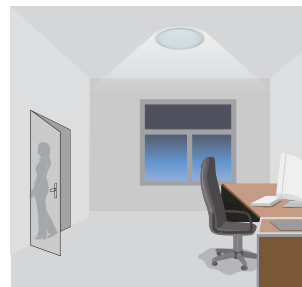

After hold-time, the light dims to stand-by level if the surrounding natural light is below the daylight threshold.



Light switches off automatically after the stand-by period elapses.

### 2 Zero-cross Relay Operation

Designed in the software, sensor switches on/off the load right at the zero-cross point, to ensure that the in-rush current is minimised, enabling the maximum lifetime of the relay.

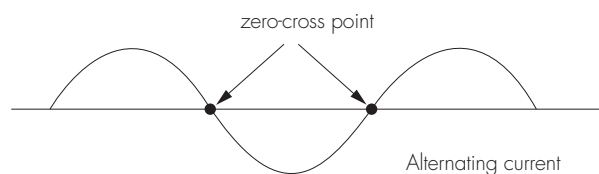

### 3 24h Daylight Monitoring Function

Our innovative and patented software enables our antenna with built-in daylight sensor to provide a "smart photocell" function. This function is activated when stand-by period is set to "+∞".

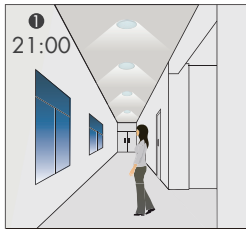

1  
21:00  
The light switches on at 100% when there is movement detected.



2  
21:10  
The light dims to stand-by level after the hold-time.

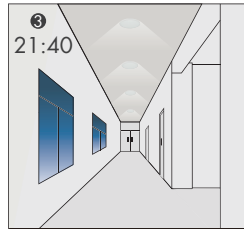

3  
21:40  
The light remains in dimming level at night.

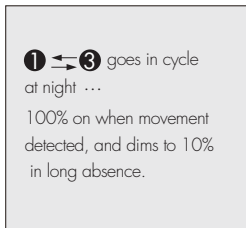

1 ↔ 3 goes in cycle at night ...  
100% on when movement detected, and dims to 10% in long absence.

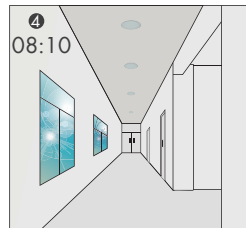

4  
08:10  
The light turns off completely when natural light lux exceeds daylight threshold pre-set.

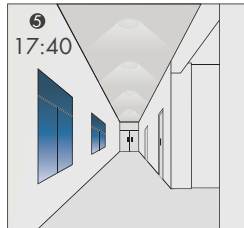

5  
17:40  
The light automatically turns on at 10% when natural light is insufficient (no motion).

#### Settings on this demonstration:

Hold-time: 10min  
Daylight threshold: 50lux  
Stand-by dimming level: 10%  
Stand-by period: +∞

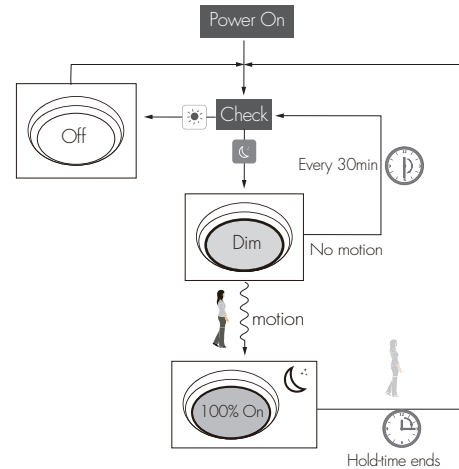

### 4 Manual Override (for HC404VRC-KD only)

This sensor reserves the access of manual override function for end-user to switch on/off, or adjust the brightness by push-switch, which makes the product more user-friendly and offers more options to fit some extra-ordinary demands:

- \* Short Push (< 1 s): on/off function;
  - On → Off: the light turns off immediately and cannot be triggered ON by motion until the expiration of pre-set hold-time. After this period, the sensor goes back to normal sensor mode.
  - Off → On: the light turns on and goes to sensor mode, no matter if ambient Lux level exceeds the daylight threshold or not.
- \* Long Push (> 1 s): adjust the hold-time brightness level between 10% and 100%.

*Note: if end-user do not want this manual override function, just leave the "push" terminal unconnected to any wire.*

### 5 Semi-auto Mode (Absence Detection, for HC404VRC-KD only)

It is easy to forget to switch off the light, in office, corridor, even at home. And in many other cases, people do not want to have a sensor to switch on the light automatically, for example, when people just quickly pass-by, there is no need to have the light on. The solution is to apply this "absence detector": motion sensor is employed, but only activated on the manual press of the push switch, the light keeps being ON in the presence, and dims down in the absence, and eventually switches off in the long absence.

This is a good combination of sensor automation and manual override control, to have the maximum energy saving, and at the same time, to keep efficient and comfortable lighting.

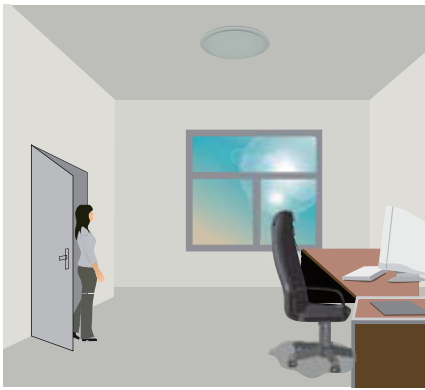

The light does not switch on when there is presence being detected.



Short push to activate the sensor and switch on the light

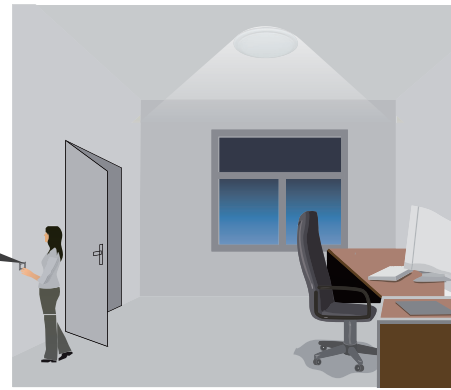

The light turns on full, and the sensor stays in sensor mode.



The light keeps being ON during the presence.

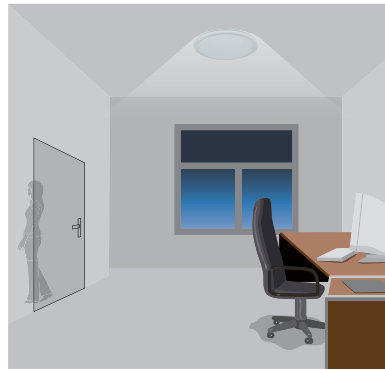

People left, the light dims to stand-by level after the hold-time.



The light switches off automatically after the stand-by period elapses.

Note: end-user can choose either function 4 or function 5 for application. Default function is manual override.

### 6 Loop-in and Loop-out Terminal

Double L N terminal makes it easy for wire loop-in and loop-out, and saves the cost of terminal block and assembly time.

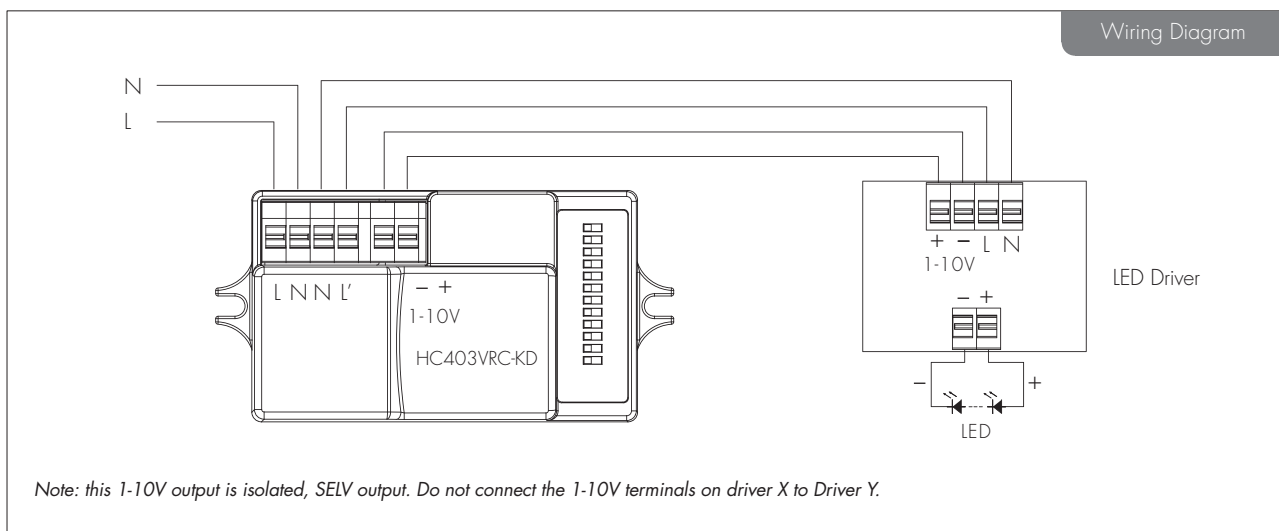

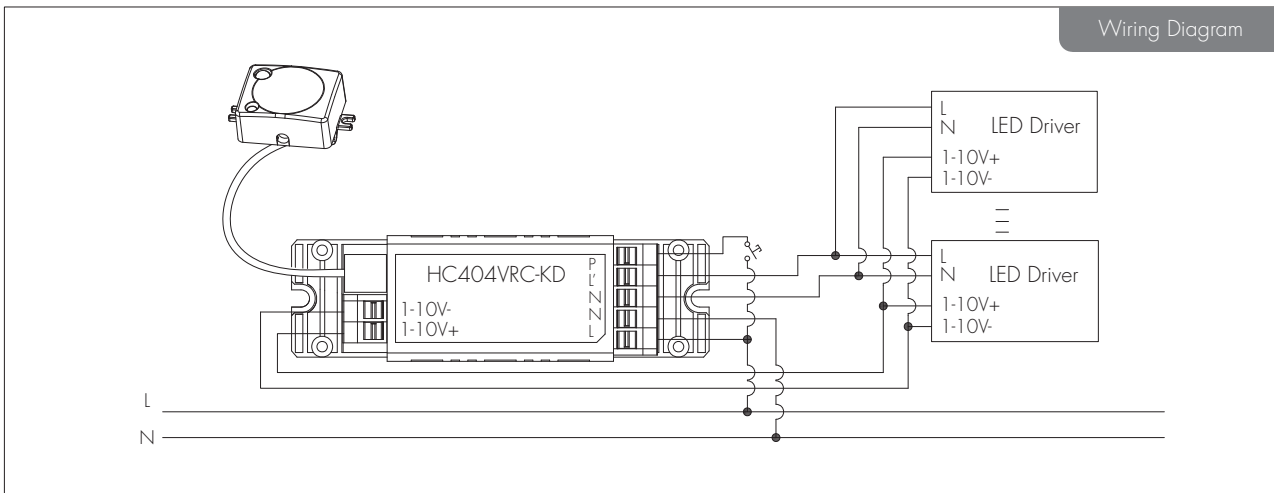

### Settings (Remote Control HRC-05, for SAM5 & SAM6)

#### **ON/OFF** Permanent ON/OFF function

Press the "ON/OFF" button, the light goes to permanent on or permanent off mode, and the sensor is disabled.

\* Press "Auto Mode", "RESET" or "Scene mode" buttons to quit this mode.

#### **Auto Mode** Sensor mode

Press "Auto Mode" button, the sensor starts to function and all settings remain the same as the latest status before the light is switched on/off.

#### **RESET** Reset function

Press "RESET" button, all settings go back to default settings.

#### **+** **-** Dim +/-

Long press "Dim +" or "Dim -" to adjust the light brightness during hold-time. "+" means dimming up, "-" means dimming down.

#### **TEST 2S** Test mode

This button is for testing purpose only. The sensor goes to test mode (hold-time is 2s) after commissioning, meanwhile the stand-by period and daylight sensor are disabled.

\* This mode can be ended by pressing "reset", or any button of "scene mode" and "hold-time". The sensor settings are changed accordingly.

#### **Power 100%** **Power 80%** Power output

By pressing these two buttons, the output shifts between 80% (at initial 10,000 hours) and 100%, for energy saving purpose.

#### **Daylight Sensor** Ambient daylight threshold

Press this button, the latest surrounding lux value overwrites the previous lux value learned, and it is set as the daylight threshold. This feature enables the fixture to function well in any real application circumstances.

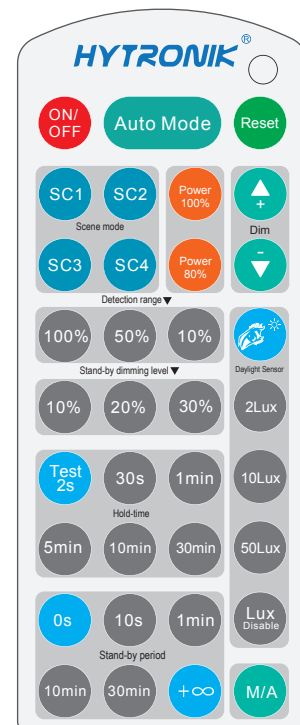

HRC-05

*Note: the buzzer beeps one time when RC receives signal successfully.*

**Lux Disable**

Press this button, the built-in daylight sensor stops working, and all motion detected could turn on the lighting fixture, no matter how bright the natural light is.

**M/A Manual override / Semi-auto mode (absence detection)**

By pressing this button, the sensor goes to manual override or Semi-auto mode (absence detection) function.

\* The buzzer beeps twice if it's manual override function, and beeps once if it shifts to Semi-auto mode (absence detection).

*Please note that this button is valid for HC404VRC-KD ONLY.*

**Scene mode**

There are 4 scene modes fixed program built in the remote control to choose for different applications:

Scene options	Detection range	Hold-time	Stand-by period	Stand-by dimming level	Daylight sensor
SC1	100%	1 min	10min	10%	2Lux
SC2	100%	5min	10min	10%	2Lux
SC3	100%	10min	30min	10%	10Lux
SC4	100%	10min	+∞	10%	50Lux

\* End-user can adjust the settings by pressing buttons of detection range/hold-time/stand-by period/stand-by dimming level/daylight sensor. The last setting stays in validity.

**Detection range**

Press the buttons of "detection range" to set detection range at 10% / 50% / 100%.

**Hold-time**

Press the buttons of "hold-time" to set hold-time at 30s / 1 min / 5min / 10min / 30min.

**Daylight sensor**

Press the buttons of "daylight sensor" to set daylight threshold at 2Lux / 10Lux / 50Lux.

**Stand-by period (corridor function)**

Press the buttons of "stand-by period" to set stand-by period at 0s / 10s / 1min / 10min / 30min / +∞.

\* "0s" means on/off control; "+∞" means bi-level dimming control, the fixture never switches off when daylight sensor is disabled.

**Stand-by dimming level**

Press the buttons of "stand-by dimming level" to set the stand-by dimming level at 10% / 20% / 30%.

**Detection Pattern (Ceiling mounted)**

Model SAM5 & SAM9

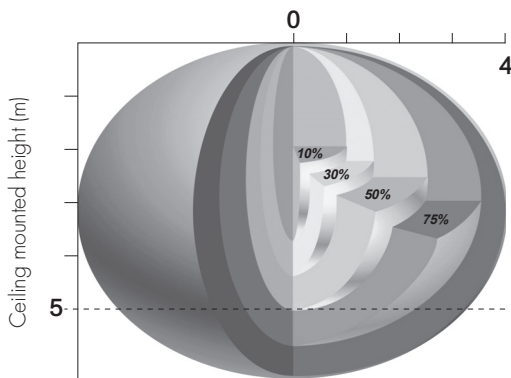

Model SAM6

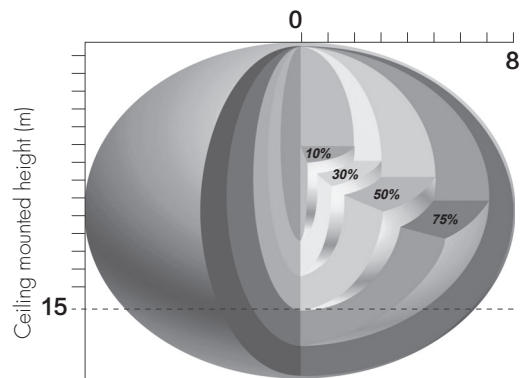

## DIP Switch Settings (HC403VRC-KD)

### 1 Detection Range

Sensor sensitivity can be adjusted by selecting the combination on the DIP switches to fit precisely for each specific application.

	1	2	
I	●	●	100%
II	●	○	75%
III	○	●	50%
IV	○	○	10%

- I – 100%
- II – 75%
- III – 50%
- IV – 10%



### 2 Hold-time

Select the dip switch configuration for the full brightness on-time after presense detection.

*Please note that this function is disabled when the natural daylight exceeds the daylight threshold setting for more than 5 minutes.*

	1	2	3	
I	●	●	●	5s
II	●	●	○	30s
III	●	○	●	1min
IV	●	○	○	5min
V	○	●	●	10min
VI	○	●	○	20min
VII	○	○	○	30min

- I – 5s
- II – 30s
- III – 1min
- IV – 5min
- V – 10min
- VI – 20min
- VII – 30min



### 3 Daylight Threshold

Set the level according to the fixture and environment. The light will not turn on if ambient lux level exceeds the daylight threshold preset.

*Please note that the ambient lux level refers to internal light reaching the sensor.*

Disabling the daylight sensor will put the sensor into occupancy detection only mode.

	1	2	
I	●	●	Disable
II	●	○	50Lux
III	○	●	10Lux
IV	○	○	2Lux

- I – Disable
- II – 50Lux
- III – 10Lux
- IV – 2Lux



### 4 Stand-by period (corridor function)

This is the time period you would like to keep at the low light output level before it is completely switched off in the long absence of people.

*Note: "0s" means on/off control;*

*"+ ∞" means the stand-by time is infinite and the fixture never switches off.*

	1	2	3	
I	●	●	●	0s
II	●	●	○	10s
III	●	○	●	1min
IV	●	○	○	5min
V	○	●	●	10min
VI	○	●	○	30min
VII	○	○	●	1H
VIII	○	○	○	+∞

- I – 0s
- II – 10s
- III – 1min
- IV – 5min
- V – 10min
- VI – 30min
- VII – 1H
- VIII – +∞



### 5 Stand-by dimming level

The setting is used to select the desired dimmed light level used in periods of absence for enhanced comfort and safety.

	1	2	
I	●	●	10%
II	●	○	20%
III	○	●	30%
IV	○	○	50%

- I – 10%
- II – 20%
- III – 30%
- IV – 50%

