



■ Features :

- Universal AC input / Full range
- Protections: Short circuit / Over current / Over voltage
- Built-in active PFC function
- Cooling by free air convection
- Class 2 power unit
- Output current level adjustable
- 100% full load burn-in test
- High reliability
- Suitable for built-in applications of LED lighting
- 2 years warranty



■ GTIN CODE

MW Search: <https://www.meanwell.com/serviceGTIN.aspx>



(for 48V only)



(except for 48V)



SPECIFICATION

MODEL	PLP-60-12	PLP-60-24	PLP-60-48	
OUTPUT	DC VOLTAGE	12V	24V	48V
	CONSTANT CURRENT REGION <small>Note.5</small>	9 ~ 12V	18 ~ 24V	36 ~ 48V
	RATED CURRENT	5A	2.5A	1.3A
	CURRENT RANGE	0 ~ 5A	0 ~ 2.5A	0 ~ 1.3A
	RATED POWER	60W	60W	62.4W
	RIPPLE & NOISE (max.) <small>Note.2</small>	4.5Vp-p	4.5Vp-p	4.8Vp-p
	CURRENT ADJ. RANGE	3.75 ~ 5A	1.875 ~ 2.5A	0.975 ~ 1.3A
	VOLTAGE TOLERANCE <small>Note.3</small>	± 10%		
	LINE REGULATION	± 3.0%		
	LOAD REGULATION	± 5.0%		
SETUP TIME	500ms / 230VAC 1200ms / 115VAC at full load			
INPUT	VOLTAGE RANGE <small>Note.4</small>	90 ~ 264VAC 127 ~ 370VDC		
	FREQUENCY RANGE	47 ~ 63Hz		
	POWER FACTOR (Typ.)	PF ≥ 0.9 at 75 ~ 100% load, 115VAC / 230VAC		
	TOTAL HARMONIC DISTORTION	THD < 20% when output loading ≥ 75% at 115VAC/230VAC input		
	EFFICIENCY (Typ.)	84%	88%	89%
	AC CURRENT (Typ.)	0.8A/115VAC 0.4A/230VAC		
	INRUSH CURRENT (max.)	COLD START 35A(twidth=55μs measured at 50% I _{peak}) at 230VAC		
	MAX.No. of PSUs on 16A CIRCUIT BREAKER	32units (circuit breaker of type B) / 32 units (circuit breaker of type C) at 230VAC		
LEAKAGE CURRENT	< 0.75mA / 240VAC			
PROTECTION	OVER CURRENT <small>Note.5</small>	100 ~ 110% Protection type : Constant current limiting, recovers automatically after fault condition is removed		
	SHORT CIRCUIT	Hiccup mode, recovers automatically after fault condition is removed		
	OVER VOLTAGE	15 ~ 18V	28 ~ 35V	57 ~ 63V Protection type : Shut down o/p voltage, re-power on to recover
ENVIRONMENT	WORKING TEMP.	-30 ~ +70°C (Refer to "Derating Curve")		
	WORKING HUMIDITY	20 ~ 95% RH non-condensing		
	STORAGE TEMP., HUMIDITY	-40 ~ +80°C, 10 ~ 95% RH		
	TEMP. COEFFICIENT	± 0.03%/°C (0 ~ 50°C)		
	VIBRATION	10 ~ 500Hz, 2G 12min./1cycle, period for 72min. each along X, Y, Z axes		
SAFETY & EMC	SAFETY STANDARDS	GB19510.1, GB19510.14, UL8750, TUV BS EN/EN61347-1, BS EN/EN61347-2-13, CSA C22.2 No. 250.0-08(except for 48V), EAC TP TC 004 approved ; design refer to UL60950-1		
	WITHSTAND VOLTAGE	I/P-O/P: 3.75KVAC I/P-FG: 2KVAC O/P-FG: 0.5KVAC		
	ISOLATION RESISTANCE	I/P-O/P, I/P-FG, O/P-FG: 100M Ohms / 500VDC / 25°C / 70% RH		
	EMC EMISSION	Compliance to GB/T 17743, GB17625.1, BS EN/EN55015, BS EN/EN61000-3-2 Class C (≥ 75% load); BS EN/EN61000-3-3, EAC TP TC 020		
	EMC IMMUNITY	Compliance to BS EN/EN61000-4-2, 3, 4, 5, 6, 8, 11, BS EN/EN55035, BS EN/EN61547, light industry level, EAC TP TC 020		
OTHERS	MTBF	5065.8K hrs min. Telcordia SR-332 (Bellcore); 583.3K hrs min. MIL-HDBK-217F (25°C)		
	DIMENSION	101.6*50.8*29.6mm (L*W*H)		
	PACKING	0.16Kg; 96pcs/16.4Kg/0.89CUFT		

NOTE

1. All parameters NOT specially mentioned are measured at 230VAC input, rated load and 25°C of ambient temperature.
2. Ripple & noise are measured at 20MHz of bandwidth by using a 12" twisted pair-wire terminated with a 0.1uF & 47uF parallel capacitor.
3. Tolerance : includes set up tolerance, line regulation and load regulation.
4. Derating may be needed under low input voltage. Please check the static characteristics for more details.
5. Please refer to "DRIVING METHODS OF LED MODULE".
6. Heat sink HS1, HS2 can not be shorted.
7. Heat sink HS1 must have safety isolation distance with system case.
8. The power supply is considered as a component that will be operated in combination with final equipment. Since EMC performance will be affected by the complete installation, the final equipment manufacturers must re-qualify EMC Directive on the complete installation again. (as available on https://www.meanwell.com/Upload/PDF/EMI_statement_en.pdf)
9. Direct connecting to LEDs is suggested, but is not suitable for using additional drivers.
10. To fulfill requirements of the latest ErP regulation for lighting fixtures, this LED power supply can only be used behind a switch without permanently connected to the mains.
11. The power supply is considered a component which will be installed into a final equipment. All the EMC tests are been executed by mounting the unit on a 360mm*360mm metal plate with 1mm of thickness. The final equipment must be re-confirmed that it still meets EMC directives. For guidance on how to perform these EMC tests, please refer to "EMI testing of component power supplies." (as available on https://www.meanwell.com/Upload/PDF/EMI_statement_en.pdf)
12. PLP-60-12 is used for any light source that exempt from the ErP-Directive (EU) 2019/2020 requirement, for example this model could be use for signalling products(including, but not limited to road-, railway-, marineorair traffic-signalling , traffic control or airfield lamps) .

※ Product Liability Disclaimer : For detailed information, please refer to <https://www.meanwell.com/serviceDisclaimer.aspx>

■ Mechanical Specification

Unit:mm

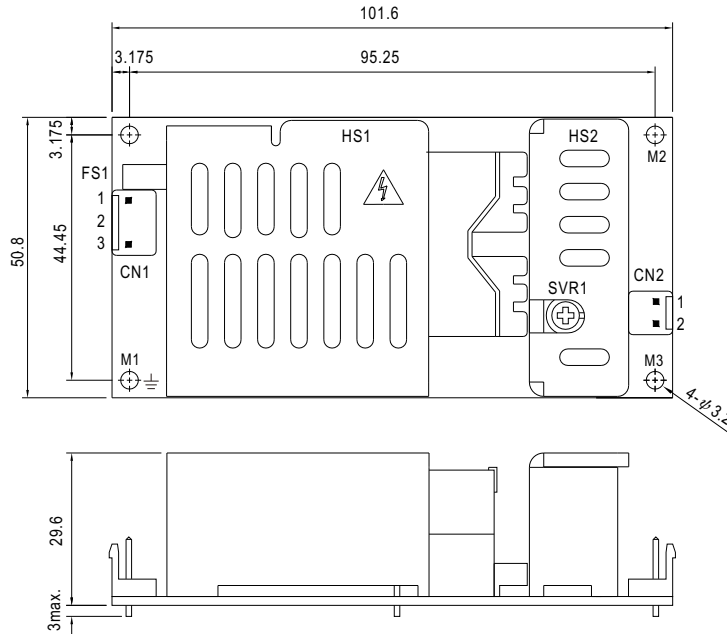

- ⚠ 1.HS1,HS2 cannot be shorted.
- 2.HS1 must have safety isolation distance with system case.
- 3.M1 is safety ground. For better EMC performance,Please secure an electrical connection between M1,M2,M3,and chassis grounding.

AC Input Connector (CN1) : JST B3P-VH or equivalent

Pin No.	Assignment	Mating Housing	Terminal
1	AC/L	JST VHR or equivalent	JST SVH-21T-P1.1 or equivalent
2	No Pin		
3	AC/N		

DC Output Connector (CN2) : JST B2P-VH or equivalent

Pin No.	Assignment	Mating Housing	Terminal
1	+V	JST VHR or equivalent	JST SVH-21T-P1.1 or equivalent
2	-V		

⊥ : Grounding Required

■ Block Diagram

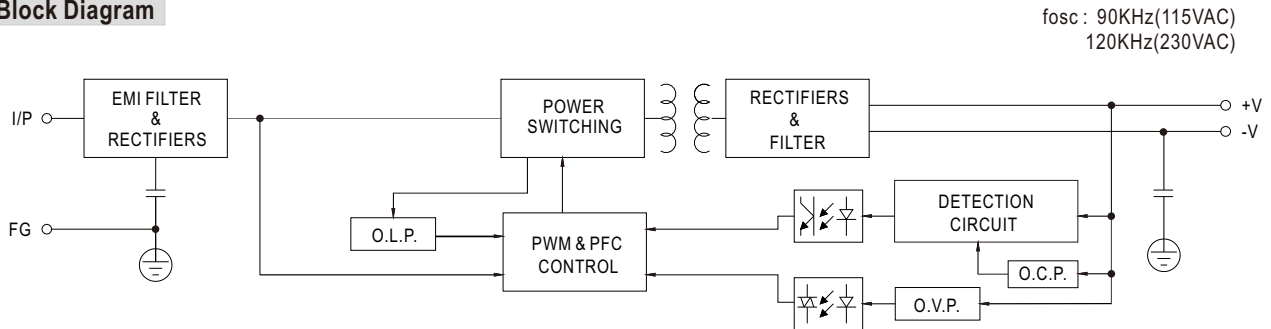

■ Derating Curve

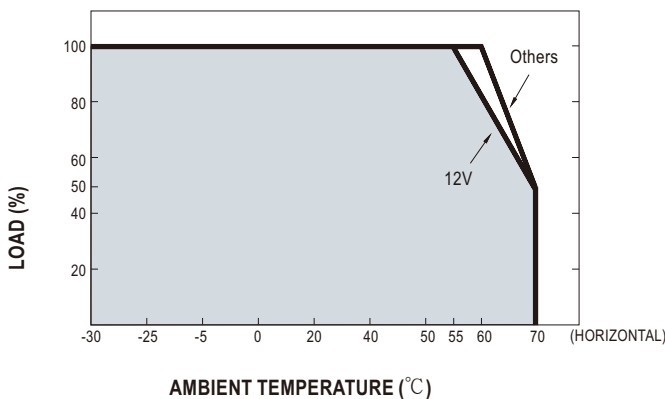

■ Static Characteristics

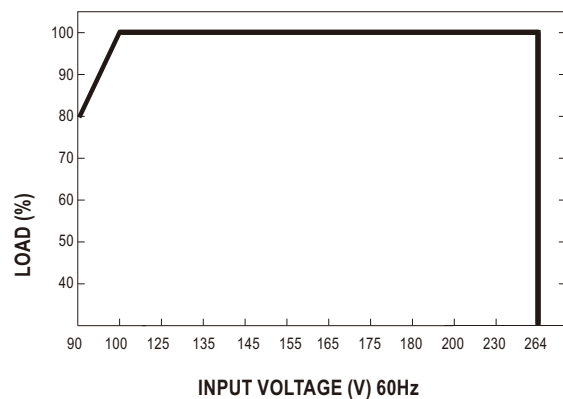

Power Factor Characteristic

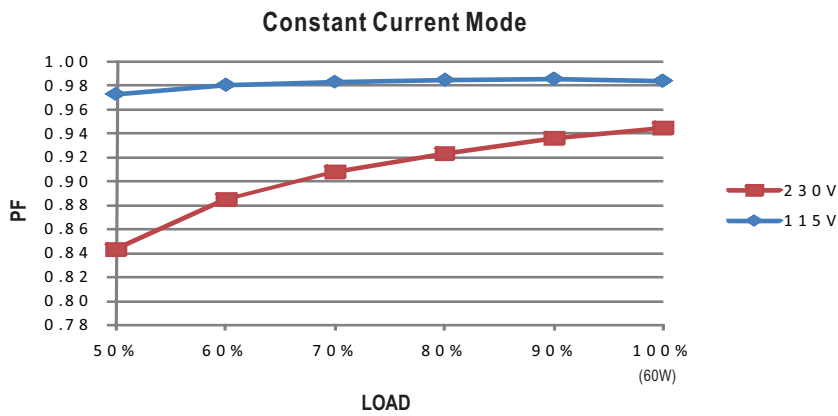

EFFICIENCY vs LOAD (48V Model)

PLP-60 series possess superior working efficiency that up to 89% can be reached in field applications.

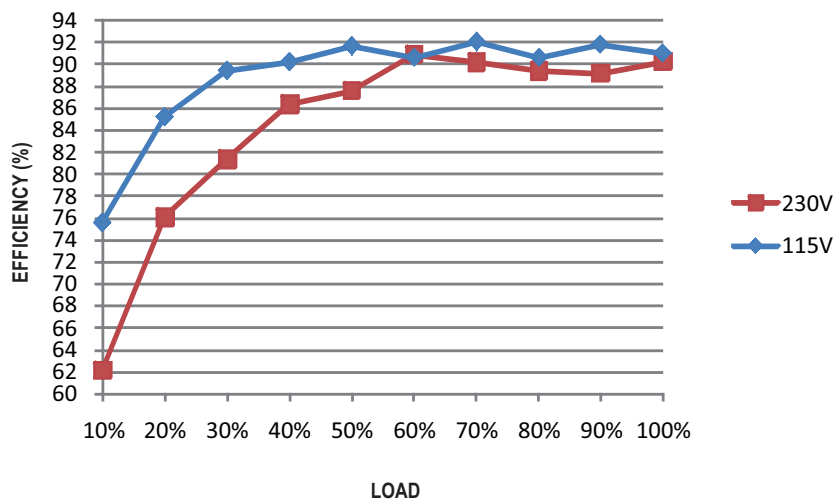

DRIVING METHODS OF LED MODULE

This LED power supply is suggested to work in constant current mode area (CC) to drive the LEDs.

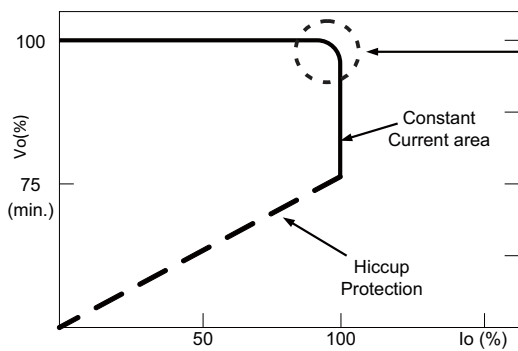

Typical LED power supply I-V curve

In the constant current region, the highest voltage at the output of the driver depends on the configuration of the end systems. Should there be any compatibility issues, please contact MEAN WELL.