

# Stand-alone Dual Sense Motion Sensor **DUALsense™**

# HYTRONIK®

## HIM11

HF and PIR, 1-10V Dimming with Remote Control

### Mechanical Structure

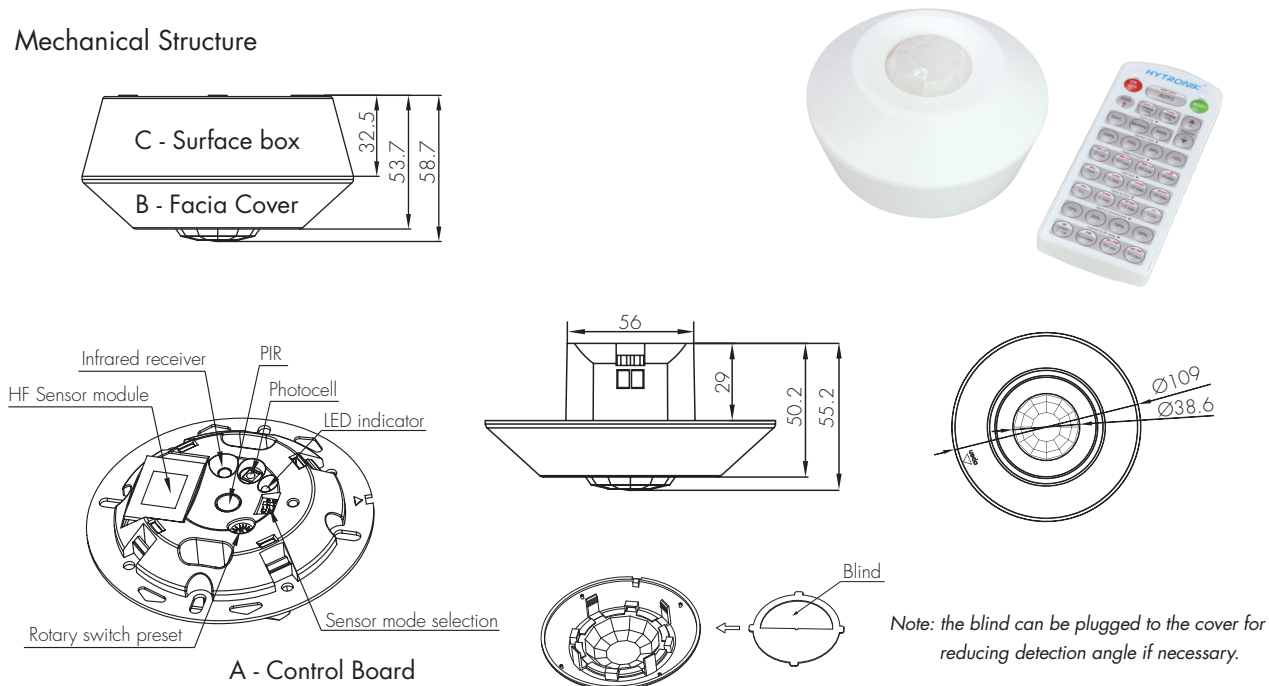

### Installation:

For more details, please refer to user manual.

- 1 Direct junction "J" box mounting



- 2 Surface mount assembly



### Technical Data

#### Input Characteristics

Model No.	HIM11
Mains voltage	120~277VAC 50/60Hz
Stand-by power	<1W
Load ratings:	
Capacitive	400VA@120V; 800VA@220-277V
Resistive	700W@120V; 1600W@220-277V
Warming-up	30s

#### Sensor Data

Model No.	HIM11
Sensor principle	High Frequency (microwave), PIR
Operation frequency	5.8GHz +/- 75MHz (HF)
Transmission power	<0.2mW (HF)
Sensor mode	4 modes: PIR, HF, PIR+HF, PIR/HF
Detection range	Max. (∅ x H) 12m x 6m
Detection angle	360°

#### Safety and EMC

EMC standard (EMC)	EN55015, EN61000
Safety standard (LVD)	EN60669, AS/NZS60669
Radio Equipment (RED)	EN300440, EN301489-1, EN62479
Certification	Semko, CB, CE, EMC, RED, SAA

#### Environment

Operation temperature	Ta: -20°C ~ +55°C
IP rating	IP20

CE emc RED SAA CB IP20

## Dual Sense Introduction

It's commonly known Microwave and Infrared are main detecting technologies in lighting controls. Both have the advantage and disadvantage for industrial applications.

### Advantage

- \* sensitive to minor motion.
- \* sensitive to radial movement.
- \* can be reflected by objects hence covering big detection area
- \* resilient to heat source, smoke and air conditioner.



### Advantage

- \* no penetration, confined detection area.
- \* sensitive to tangential movement.
- \* resilient to motion object which has no heat radiation.



### Disadvantage

- \* penetrates walls, picks up motions outside of the office area;
- \* back wave detection, false trigger by motions at the back.
- \* can be false triggered by ventilation fans, water pipe, elevators etc. in industrial application.

### Disadvantage

- \* can be false triggered by air conditioner, smoke and other heat sources.

The remedy is to create Dual Sense by combining both technologies to make use of the advantage and bypass the disadvantage.

### 4 optional detection modes via DIP switch or remote control:

- \* HF: Microwave only
- \* PIR: PIR mode only
- \* HF+PIR: both PIR and microwave mode, to decrease the detection capability and detection area. Only when both detections are activated, the motion is considered valid. This is to prevent the sensor from false trigger by heat source, air conditioner, ventilation fans, water pipe and elevators etc...
- \* HF/PIR: either PIR or microwave mode, to increase the detection capability and detection area;

	1	2	
I	●	●	HF
II	○	●	PIR
III	●	○	HF+PIR
IV	○	○	HF/PIR





## Functions and Features

### 1 Intelligent Photocell (daylight detection prior to motion detection)

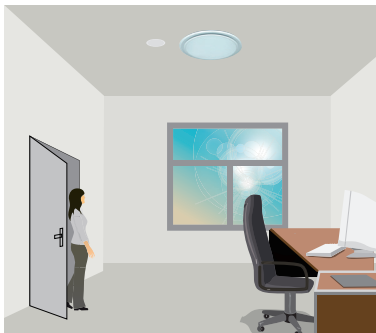
The built-in photocell will also automatically turn off the light when the ambient natural light exceeds the programmed lux level for more than 5min, regardless of whether motion is detected or not. This feature can be disabled if it is required that the fixture stays at dimmed level during absence.

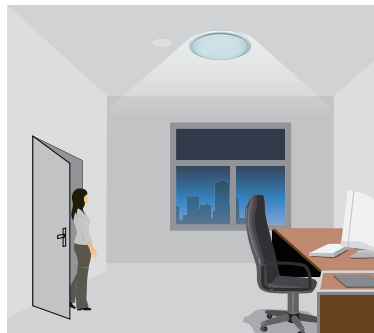

With sufficient natural light, the light does not switch on when presence is detected.



With insufficient natural light, the sensor switches on the light automatically when presence is detected.

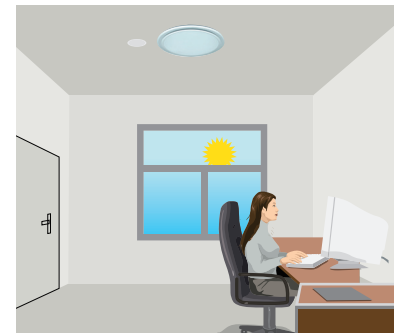

The sensor switches off the light when natural light is sufficient, even with presence.

*Note: if the stand-by time is preset at "+∞", the fixture never switches off but stays at preset dimming level even when natural light is sufficient.*

## 2 Tri-level Control (Corridor Function)

Hytronik builds this function inside the motion sensor to achieve tri-level control, for some areas which require a light change notice before switch-off. The sensor offers 3 levels of light: 100%→dimmed light (natural light is insufficient)→off; and 2 periods of selectable waiting time: motion hold-time and stand-by period; Selectable daylight threshold and freedom of detection area.

## 3 Manual Override

With the help of push-switch, this sensor can be over-ridden by the end-user to manually switch on/off the light, or adjust the brightness by push-switch, which makes the product more user-friendly and offers more options to fit some extra-ordinary demands:

\* Short Push (< 1 s): on/off function;

On → Off: the light turns off immediately and cannot be triggered ON by motion until the expiration of pre-set hold-time. After this period, the sensor goes back to normal sensor mode.

Off → On: the light turns on and goes to sensor mode, no matter if ambient Lux level exceeds the daylight threshold or not.

\* Long Push (> 1 s): adjust the hold-time brightness level between 10% and 100%.

*Note: if end-user do not want this manual override function, just leave the "push" terminal unconnected to any wire.*

## 4 Semi-auto Mode (Absence Detection)

It is easy to forget to switch off the light, in office, corridor, even at home. And in many other cases, people do not want to have a sensor to switch on the light automatically, for example, when people just quickly pass-by, there is no need to have the light on. The solution is to apply this "absence detector": motion sensor is employed, but only activated on the manual press of the push-switch, the light keeps being ON in the presence, and dims down in the absence, then switches off in the long absence.

*Note: end-user can choose either function 3 or function 4 for application. Default function is manual override.*

## 5 Zero-cross Relay Operation

Designed in the software, sensor switches on/off the load right at the zero-cross point, to ensure that the in-rush current is minimised, enabling the maximum lifetime of the relay.

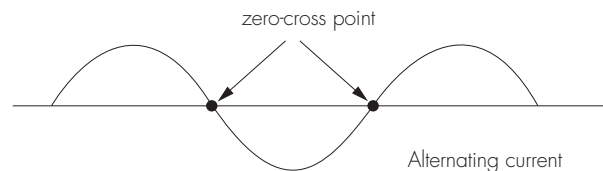

## 6 Loop-in and Loop-out Terminal

Double L N terminal makes it easy for wire loop-in and loop-out, and saves the cost of terminal block and assembly time.

### Detection Pattern

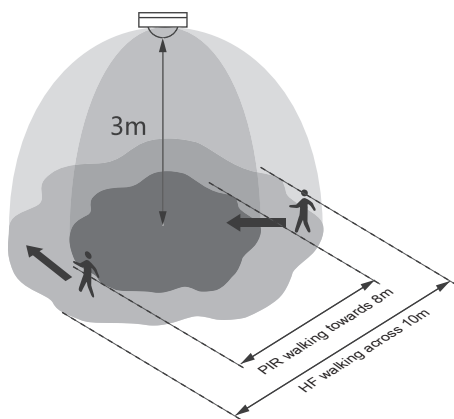

### Wiring Diagram

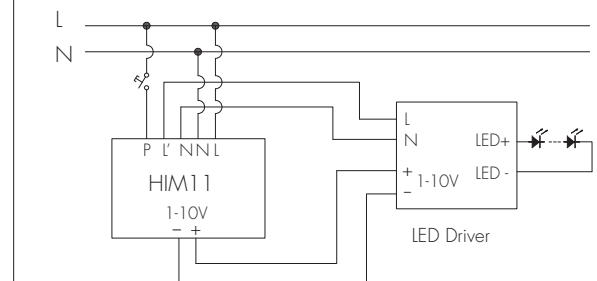

## Settings (Remote Control HRC-11)



### Permanent ON/OFF function

Press button "ON/OFF" to select permanent ON or permanent OFF mode.

\* Press button "AUTO", "RESET" to quit this mode.



### Reset Settings

Press button "RESET", all settings go back to rotary switch settings. Sensor detection mode returns to DIP switch settings.



### Shift Button

Press button "Shift", the LED on the top left corner will flash to indicate mode selection. All values / settings in RED are valid for 20 seconds.



### AUTO mode

Press button "AUTO" to initiate automatic mode. The sensor starts working and all settings remain as before the light is switched ON/OFF.



### SEMI-AUTO mode

1. Press button "Shift", the red LED flashes for indication.
2. Press button "SEMI-AUTO/AUTO" to initiate semi-auto mode. The fixture is manually turned on by pressing the push-switch, and goes off automatically in this mode. (Absence detection mode)



### Power output

Press the buttons to select light output at 80% (at initial 10,000 hours) or 100%.

Note: "Sensor off" and "Twilight" functions are disabled.



### Brightness +/-

Press the buttons to adjust the light brightness during hold-time.



### Scene program - 1-key commissioning

1. Press button "Start" to program.
2. Select the buttons in "Detection range", "Daylight threshold", "Hold-time", "Stand-by time", "Stand-by dimming level" to set all parameters.
3. Press button "Memory" to save all the settings programmed in the remote control.
4. Press button "Apply" to set the settings to each sensor unit(s).

For example, to set detection range 100%, daylight threshold Disable, hold-time 5min, stand-by time +∞, stand-by dimming level 30%, the steps should be: Press button "Start", button "100%", "Disable", "Shift", "5min", "Shift", "+∞", "30%", "Memory". By pointing to the sensor unit(s) and pressing "Apply", all settings are passed on the sensor(s).

### Detection range

Press buttons in zone "Detection range" to set HF detection range at 100% / 75% / 50% / 10%.

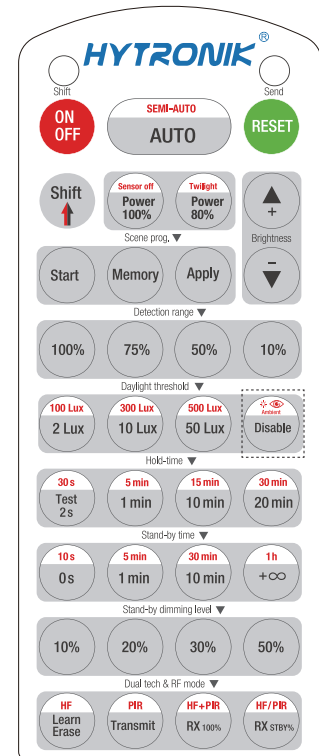

HRC-11

### Daylight threshold

Press buttons in zone "Daylight threshold" to set daylight sensor at 2Lux / 10Lux / 50Lux / 100Lux / 300Lux / 500Lux / Disable.

*Note: To set daylight sensor at 100Lux / 300Lux / 500Lux, press "Shift" button first.*

### Ambient daylight threshold

1. Press button "Shift", the red LED starts to flash.
2. Press button "Ambient", the surrounding lux level is sampled and set as the new daylight threshold.

### Hold-time

Press buttons in zone "hold-time" to set the hold-time at 2s / 30s / 1min / 5min / 10min / 15min / 20min / 30min.

*Note: 1. To set hold-time at 30s / 5min / 15min / 30min, press "Shift" button first.*

2. 2s is for testing purpose only, stand-by period and daylight sensor settings are disabled in this mode.

\*To exit from Test mode, press button "RESET" or any button in "Hold-time".

### Stand-by time (corridor function)

Press buttons in zone "stand-by time" to set the stand-by period at 0s / 10s / 1min / 5min / 10min / 30min / 1h / +∞.

*Note: "0s" means on/off control; "+∞" means bi-level control, the fixture is 100% on when there is motion detected, and remains at the stand-by dimming level when no presence after motion hold-time.*

### Stand-by dimming level

Press the button in zone "stand-by dimming level" to set the stand-by dimming level at 10% / 20% / 30% / 50%.

### Dual tech & RF mode

1. Press buttons in this zone to select sensor technology.  
 HF+PIR: the light is on when both HF and PIR sensors are activated.  
 HF/PIR: the light is on when HF or PIR sensors are activated.
2. Learn / Erase, Transmit, RX100% and RX STBY% are disabled.

## Rotary Switch Preset

A rotary switch is built inside the sensor for scene selection / fast programming. Total 16 channels are available:



Rotary switch preset

*Note: settings can also be changed by remote control HRC-11. The last action controls.*

Channel	Detection range	Hold-time	Daylight sensor	Stand-by time	Stand-by dim level
0	100%	5s	Disable	10s	10%
1	100%	1min	2Lux	5min	10%
2	100%	5min	10Lux	10min	10%
3	100%	5min	30Lux	30min	10%
4	100%	5min	10Lux	0s	Disable
5	100%	5min	30Lux	+∞	10%
6	100%	5min	Disable	+∞	30%
7	100%	10min	2Lux	10min	10%
8	100%	10min	10Lux	30min	10%
9	100%	10min	30Lux	+∞	10%
A	100%	10min	Disable	+∞	30%
B	75%	10min	30Lux	+∞	10%
C	50%	10min	10Lux	+∞	10%
D	100%	30min	50Lux	+∞	10%
E	100%	30min	Disable	+∞	30%
F	100%	5s	2Lux	10s	10%