

User's Manual

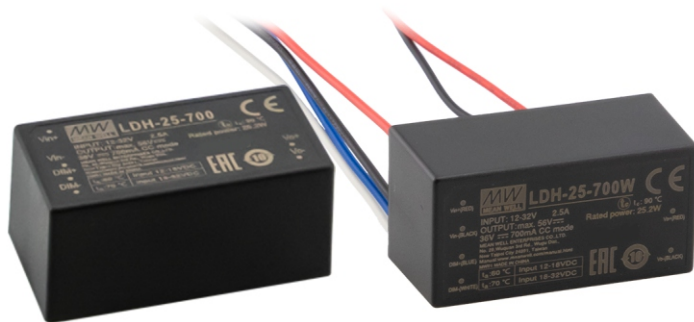

(Pin mounted style)

(Lead wire style)



Features

- Wide DC input voltage operation 9.5~32V
- DC/DC step-up converter
- Constant current output : 250mA to 700mA
- Wide output LED forward voltage up to 84V DC
- High efficiency up to 95.5%
- 2 in 1 dimming (0-10V, PWM)
- Protections: Short circuit / Over voltage
- Cooling by free air convection
- Fully encapsulated
- 3 years warranty

Applications

- DC battery source lighting
- Portable lighting
- LED solar street lighting
- LED greenhouse lighting
- LED Low-bay lighting

GTIN CODE

MW Search: <https://www.meanwell.com/serviceGTIN.aspx>

Description

LDH-25 series is a 25W DC/DC LED driver featuring constant current output. LDH-25 operates from 9.5~32VDC and offers models with different rated current ranging between 250mA and 700mA. With the high efficiency up to 95.5%, The 94V-0 flame retardant plastic case the fully-potted silicone enhance the heat dissipation allows this series to fit solar LED street light. LDH-25 is equipped with various function options, such as dimming methodologies, so as to provide the optimal design flexibility for DC source LED lighting system.

Model Encoding

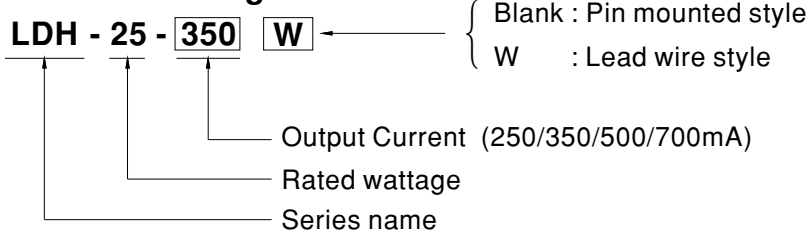

SPECIFICATION

MODEL	LDH-25-250	LDH-25-350	LDH-25-500	LDH-25-700					
OUTPUT	RATED CURRENT	250mA	350mA	500mA	700mA				
	CURRENT ACCURACY(Typ.)	±5% at 12VDC input and 24 VDC Input							
	VOLTAGE RANGE Note.2	12.5~84VDC	12.5~72VDC	12.5~50VDC	12.5~36VDC				
	RATED POWER	21W	25.2W	25W	25.2W				
	CURRENT RIPPLE	5%(@rated current)							
INPUT	VOLTAGE RANGE Note.2	9.5~32VDC							
	EFFICIENCY (Typ.)	91.5%/12V	94%/24V	92%/12V	95%/24V	91.5%/12V	94%/24V	92.5%/12V	95.5%/24V
	DC CURRENT (Typ.)	2.5A/12VDC, 1.2A/24VDC							
DIMMING	DIMMING FUNCTION Note.2	Leave open if not used 1KHz-3KHz 10V PWM signal or 0-10V DC input							
	QUIESCENT INPUT CURRENT IN SHUTDOWN MODE(Typ.)	7mA when PWM dimming OFF @12VDC							
PROTECTION	SHORT CIRCUIT	Output short circuit, the power supply will be damaged							
	OVER VOLTAGE	85~120V	73~100V	51~80V	37~60V				
	NO LOAD	Output voltage rise to OVP, and drop equal to input voltage, re-power to recovery							
ENVIRONMENT	WORKING TEMP.	-40 ~ +70°C (Refer to "Derating Curve")							
	WORKING HUMIDITY	20 ~ 90% RH non-condensing							
	STORAGE TEMP., HUMIDITY	-40 ~ +85°C, 10 ~ 95% RH							
	TEMP. COEFFICIENT	±0.03%/°C (0 ~ 50°C)							
	VIBRATION	10 ~ 500Hz, 2G 10min./1cycle, period for 60min. each along X, Y, Z axes							
SAFETY & EMC	SAFETY STANDARDS	LVD BS EN/EN61347-1, BS EN/EN61347-2-13, EAC TP TC 004 approved							
	EMC EMISSION Note.5	Compliance to BS EN/EN55015;EAC TP TC 020							
	EMC IMMUNITY	Compliance to BS EN/EN61547,BS EN/EN61000-4-2,3,4,6,8; light industry level,EAC TP TC 020							
OTHERS	MTBF	12369.5K hrs min. Telcordia TR/SR-332(Bellcore); 896.4Khrs min. MIL-HDBK-217F (25°C)							
	DIMENSION	52.4*27.2*24mm (L*W*H)							
	PACKING	Pin mounted style: 50g, 200pcs/11Kg/0.89CUFT; Lead wire style: 57g, 200pcs/12.4kg/0.98CUFT							
NOTE	1.All parameters are specified at normal input(12VDC), rated load, 25°C 70% RH ambient. 2.Non dimming application: Output voltage must step up by 3 Volts from input DC voltage Dimming application: Output voltage must be twice higher than the input DC voltage If input voltage down below 11V, the output current may drop to more than 80% of the rated current 3.This series meets the typical life expectancy of >35,000 hours of operation when Tcase, particularly tc point (or TMP, per DLC), is about 80°C or less. 4.The ambient temperature derating of 3.5°C/1000m with fanless models and of 5°C/1000m with fan models for operating altitude higher than 2000m(6500ft). 5.BS EN/EN55015 EMI testing layout is based on DC input with a battery source ※ Product Liability Disclaimer : For detailed information, please refer to https://www.meanwell.com/serviceDisclaimer.aspx								

■ Mechanical Specification

LDH (PIN Style):

Unit: mm

■ Pin Configuration

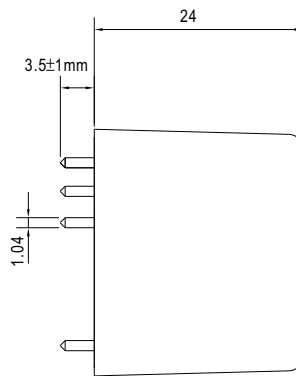
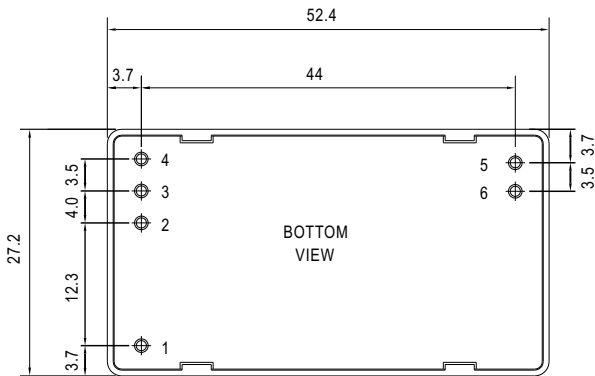

P/N diameter: 1.04

Pin No.		Comment
1	Vin+	DC Supply
2	Vin-	DC Supply, Don't connect to Vout-
3	Dim+	2 in 1 dimming
4	Dim-	2 in 1 dimming
5	Vout-	LED- connection
6	Vout+	LED+ connection

LDH (Lead Wire Style):

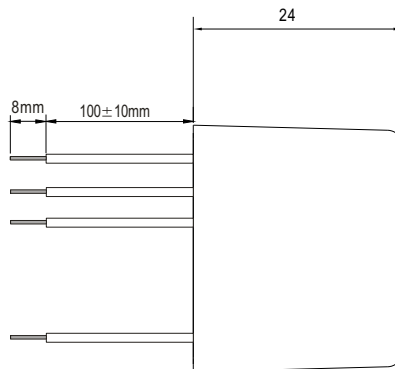
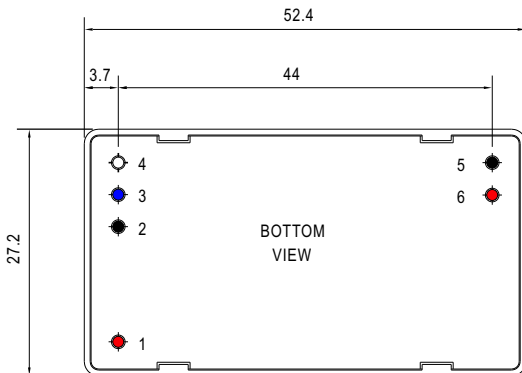

Pin No.		Comment
1	Vin+(Red)	DC Supply
2	Vin-(Black)	DC Supply Don't connect to Vout-
3	Dim+ (Blue)	2 in 1 dimming
4	Dim- (White)	2 in 1 dimming
5	Vout- (Black)	LED- connection
6	Vout+ (Red)	LED+ connection

■ Derating Curve

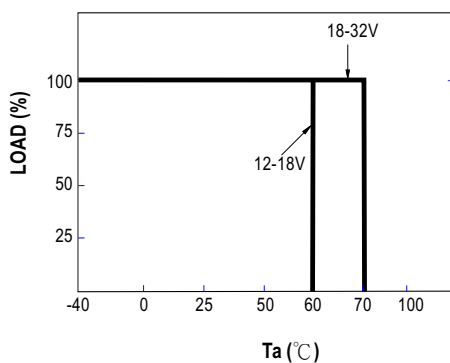

■ Static Characteristics

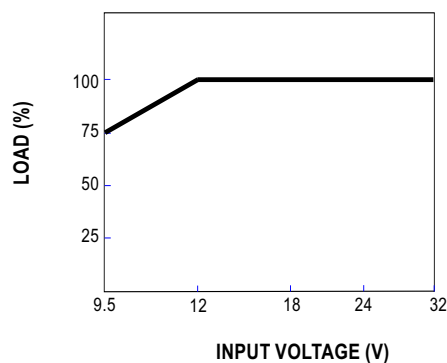

■ Standard Application

※ 2 in 1 dimming function

- Output constant current level can be adjusted by applying one of the three methodologies between DIM+ and DIM-:
0 ~ 10VDC, or 10V PWM signal
- Direct connecting to LEDs is suggested. It is not suitable to be used with additional drivers.

◎ Applying additive 0 ~ 10VDC

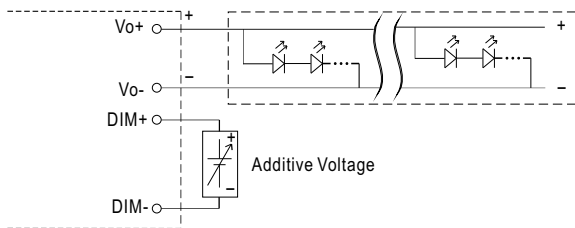

"DO NOT connect "DIM- to Vo-"

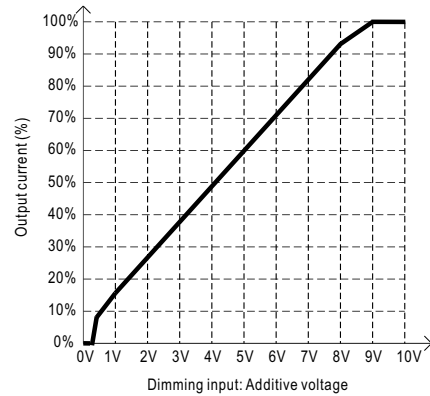

◎ Applying additive 10V PWM signal (frequency range 1KHz ~ 3KHz):

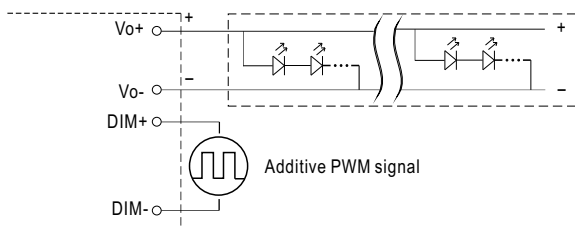

"DO NOT connect "DIM- to Vo-"

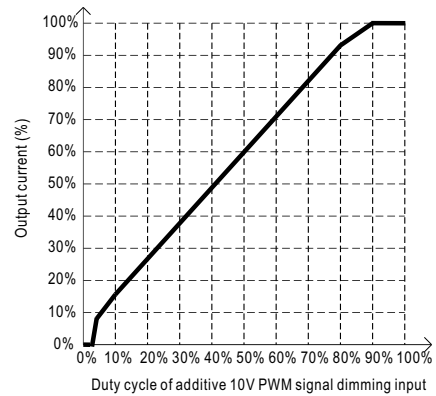

Note: 1. Min. dimming level is about 8% and the output current is not defined when $0\% < I_{out} < 8\%$.

2. The output voltage is about equal to input voltage when dimming input is about 0Vdc, or 10V PWM signal with 0% duty cycle.

■ Efficiency VS Load

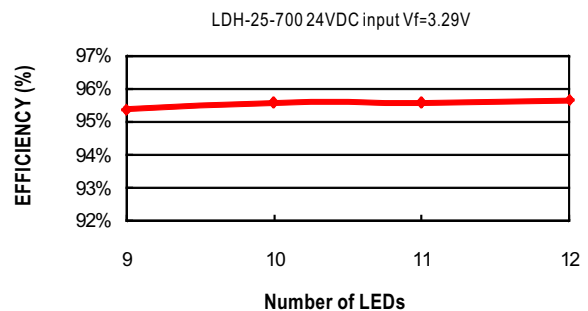
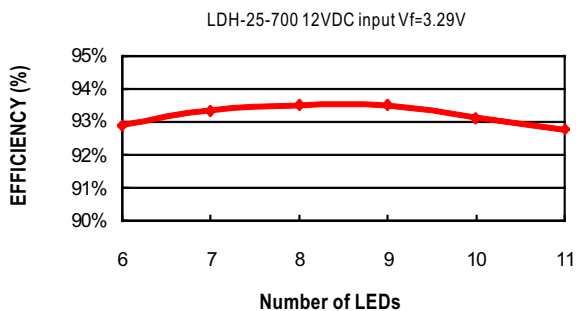
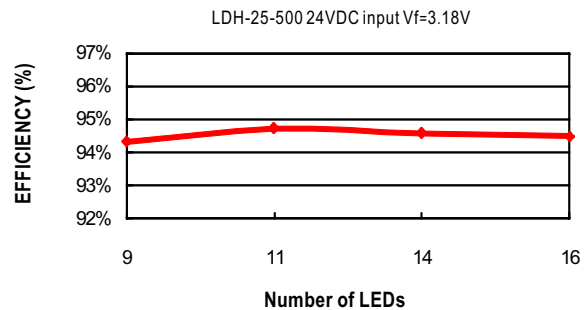
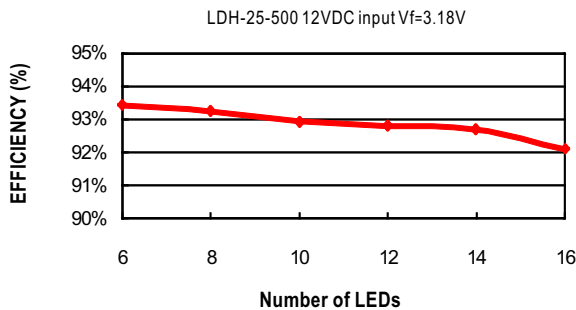
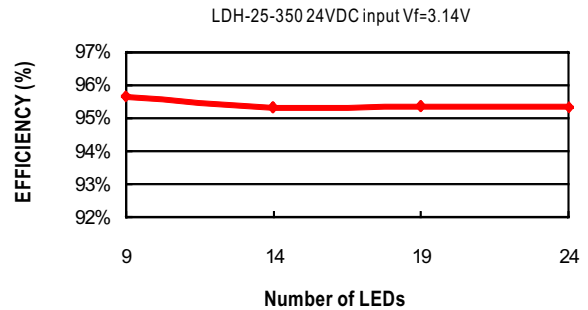
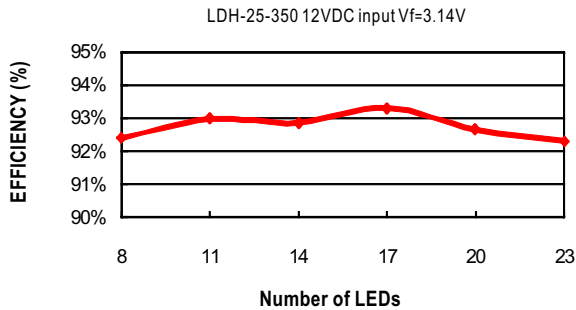
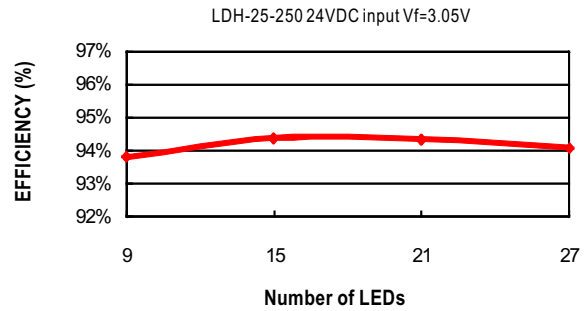
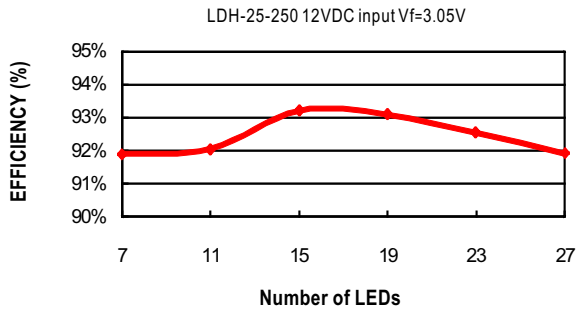

Application Notes:

1. The positive and negative input terminals must be connected correctly and negative voltage can not be input to avoid damage to the power supply.
2. Due to the large input current, please pay attention to the voltage drop of the wiring, to ensure the power supply to work properly.
3. At dim off, LDH output voltage will drop to the same level as input voltage. To get luminaires complete dark, please make luminaires are light off when they are driving by the input voltage.

■ **Application Notes of EMC**

1. If LDH-25 is powered by a battery, comply with BS EN/EN55015 without additional Input filter and capacitors.
2. If LDH-25 is powered by DC Bus, additional EMC filter parts shall be added to meet BS EN/EN55015. The recommended circuit is shown in Figure1

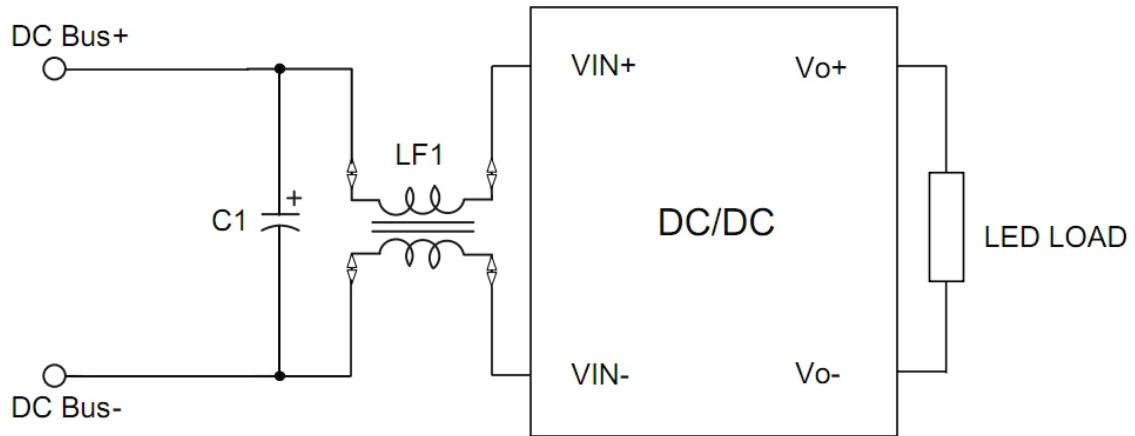

Figure 1

Figure 1: Parameter description	
C1	Electrolytic capacitor 100uF/35V
LF1	Common Mode Choke 11.5mH/Ring code(T16 × 12 × 8)/wire(0.6mm × 1)/50 Turns (Mn-Zn Ferrite/ $\mu i=10000 \pm 30\%/AL=4600nH/N^2$)